

MINOLTA

MAXXUM[®]
DYNAX[™]

7xi

E INSTRUCTION MANUAL

INTRODUCTION

The Minolta DYNAX/MAXXUM 7xi is one of the most innovative AF SLRs available. For this reason, you are holding a large and rather intimidating owner's manual. However, not everything will pertain to you immediately, so read it in sections.

First, look over the parts diagrams and familiarize yourself with the controls, their names, and their locations. This will be helpful later when they are introduced in the manual and you learn about their functions. Next, read Preparations, beginning on p.8. Follow along and attach the strap, insert a battery, etc. Get used to holding the camera, working the controls, and seeing the displays.

Then, begin where you must with anything new — The Basics. Read it well, and you should then be ready to put the 7xi to work for you in the simplest way possible. As you use the camera, you will begin to realize the power of features such as:

- Expert system programming with fuzzy logic control
- High-Speed, Multi/Omni-Dimensional Predictive autofocus
- Expert Program Selection
- Graphic Display Viewfinder
- Creative Program Control

Operations in Detail and the Appendix are there for you to increase your mastery over this unique camera and its innovative technology, and to help you expand your control over the medium of photography.

IMPORTANT INFORMATION

The Minolta DYNAX/MAXXUM 7xi was designed to work specifically with lenses, flash units, and other accessories manufactured and distributed by Minolta. We therefore caution users of this camera that the attachment and/or use of incompatible products with the 7xi may result in unsatisfactory performance or damage to the camera or its accessories. To obtain optimum performance throughout the life of your DYNAX/MAXXUM 7xi, we recommend that you use only those lenses, flashes and other accessories distributed by Minolta specifically for use with this camera.

STATEMENT OF FCC COMPLIANCE

This device complies with Part 15 of the FCC Rules. Operation is subject to the following two conditions: (1) This device may not cause harmful interference, and (2) this device must accept any interference received, including interference that may cause undesired operation. Changes or modifications not approved by the party responsible for compliance could void the user's authority to operate the equipment. This equipment has been tested and found to comply with the limits for a Class B digital device, pursuant to Part 15 of the FCC Rules. These limits are designed to provide reasonable protection against harmful interference in a residential installation. This equipment generates, uses and can radiate radio frequency energy and, if not installed and used in accordance with the instructions, may cause harmful interference to radio communications. However, there is no guarantee that interference will not occur in a particular installation. If this equipment does cause harmful interference to radio or television reception, which can be determined by turning the equipment off and on, the user is encouraged to try to correct the interference by one or more of the following measures: Reorient or relocate the receiving antenna.

Increase the separation between the equipment and receiver.

Connect the equipment into an outlet on a circuit different from that to which the receiver is connected. Consult the dealer or an experienced radio/TV technician for help.

STATEMENT OF DOC COMPLIANCE

This digital apparatus does not exceed the Class B limits for radio noise emissions from digital apparatus as set out in the Radio Interference Regulations of the Canadian Department of Communications.

TABLE OF CONTENTS

INTRODUCTION	1
NAMES OF PARTS	4

PREPARATIONS

Neckstrap	8
Eyepiece Cap	9
Lens	10
Attaching	10
Removing	11
Care of glass surfaces	11
Battery	12
Inserting	12
Battery-condition indicators	13
Battery Performance	14
Cold-weather operation	14
Film	15
Loading	15
Automatic/manual film speed setting	18
Automatic/manual rewind	20

SIMPLE OPERATION – THE BASICS

Holding the Camera	22
Taking Pictures	23
Camera-Shake Warning	25
Autofocus	26
Focus Signals	27
Focus Lock	28
Programmed Autoexposure	29
Creative Program Control	31
PA	32
Ps	35

OPERATIONS IN DETAIL

Main Switch and Eye-start	39
Focusing Details	40
Autofocus illuminator	40
Local AF area selection	41
Special focusing situations	43
Manual focus	44
Exposure Details	46
<i>Changing exposure mode</i>	46
Aperture priority	48
Shutter priority	50
Manual exposure	52
Metering modes	54
Exposure compensation	56
AE lock	58
Self-timer	59
Bulb	60
Flash System	62
Flash modes	62
P mode flash	64
A, S, and M mode flash	65
Slow-shutter sync flash	68
Remote/Wireless off-camera TTL flash	70
Film drive	74
Autozoom	76
Auto stand-by zoom	76
Image-size lock	78
Wide-view mode	80

APPENDIX

Lens Aperture and Depth of Field	84
Shutter Speed and Moving Subjects	87
Composition	88
Accessory Information	90
Care and Storage	92
Troubleshooting	94
Technical Description	95
Quick Reference Guide	98

Names of Parts/Body

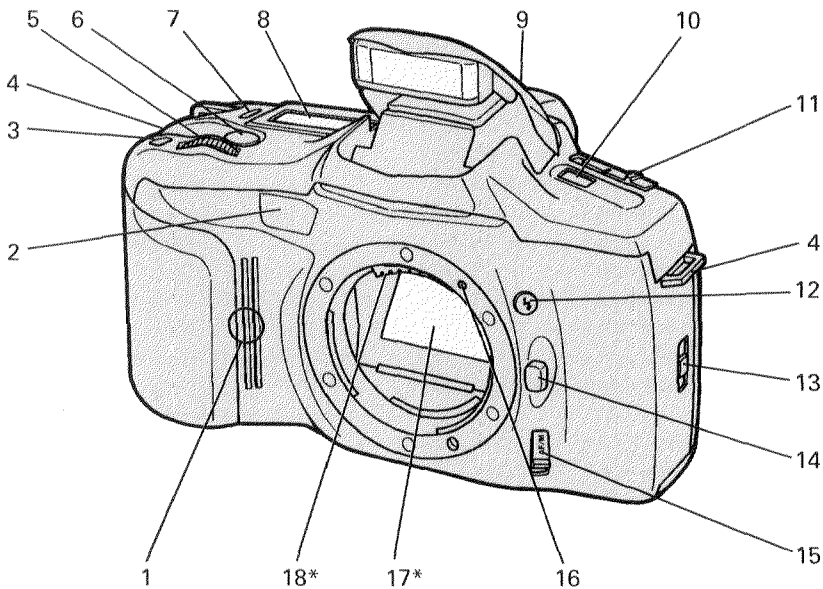

- | | |
|------------------------------------|------------------------|
| 1. Grip sensor | 13. Back-cover release |
| 2. AF illuminator/self-timer light | 14. Lens release |
| 3. Wide-view mode button | 15. Focus-mode switch |
| 4. Strap eyelet | 16. Mounting index |
| 5. Front control dial | 17. Mirror* |
| 6. Shutter-release button | 18. Lens contacts* |
| 7. Card on/off button | 19. Film chamber |
| 8. Body data panel | 20. Eyepiece sensor |
| 9. Accessory shoe | 21. Eyepiece cup |
| 10. Program-reset button | 22. AE Lock button |
| 11. Main switch | 23. Rear control dial |
| 12. Flash pop-up button | 24. Function button |
| | 25. Film window |

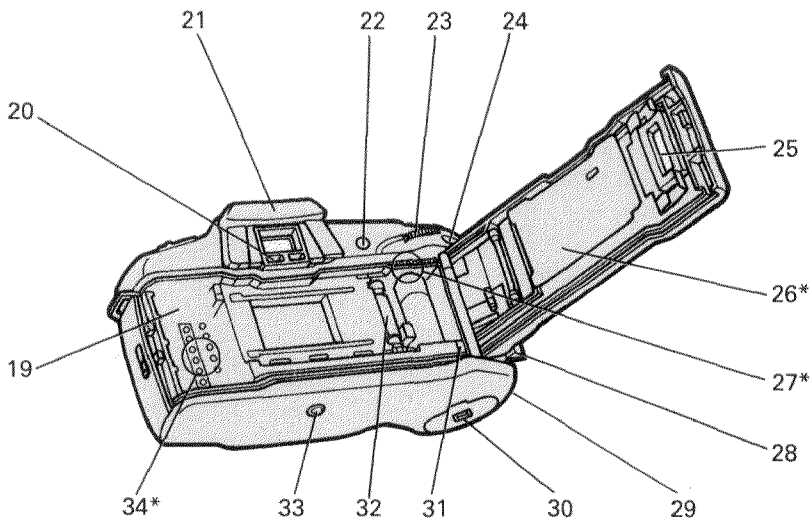

- 26. Pressure Plate*
- 27. Accessory-back contacts*
- 28. Card door
- 29. Remote-control terminal
- 30. Battery-cover release
- 31. Film-leader index
- 32. Sprocket
- 33. Tripod socket
- 34. DX contacts*
- 35. Self-timer/Drive mode button
- 36. Flash-mode button
- 37. Rewind button
- 38. ISO button
- 39. Card-adjust button
- 40. Card-eject slide

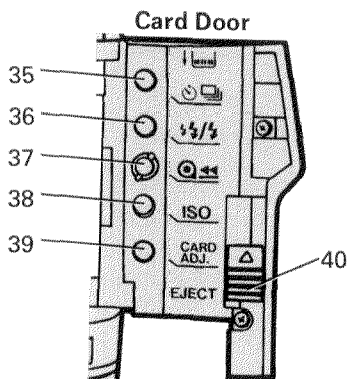

*Do not touch

Names of Parts/Body LCD

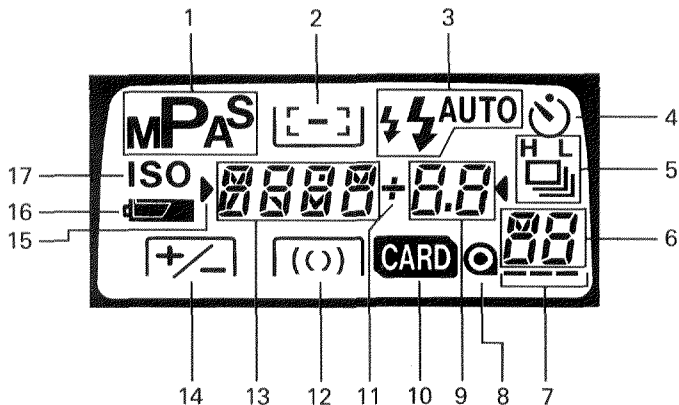

1. Exposure-mode indicators
2. Wide/Local focus indicator
3. Flash-mode indicators
4. Self-timer indicator
5. Drive-mode indicators
6. Frame counter
7. Film-transport signals
8. Film-cartridge mark
9. Aperture/Exposure Adjustment/Card setting displays
10. Card indicator
11. Exposure-adjustment indicator
12. Metering-mode indicators
13. Shutter-speed/film-speed/card name displays/
local-AF-area indicators
14. Exposure-adjustment reminder
15. Selectable Setting Pointers
16. Battery-condition indicator
17. Film-speed mark

Names of Parts/Viewfinder Screen

1. Image-size-lock indicator
2. Dial-function indicators
3. Wide-view indicator
4. Film-frame indicator
5. AF-area indicator
6. Local-AF-area indicator
7. Spot-metering area
8. Manual-focus indicator
9. Depth index
10. Action index
11. Panorama indicator
12. Image control index

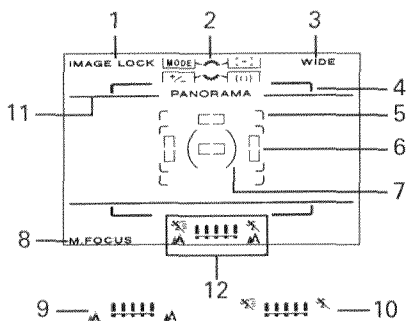

Names of Parts/Viewfinder Data Panel

1. Flash-on indicator
2. Flash-mode indicator
3. Camera-shake warning
4. Focus signals
5. Exposure-mode indicators
6. Shutter-speed/Film-speed display
7. Exposure Signals/Exposure Adjustment indicator
8. Aperture/Exposure Adjustment display
9. AEL indicator

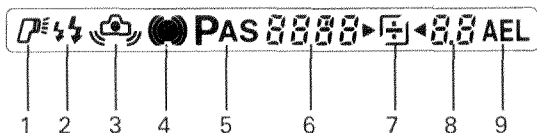

PREPARATIONS

NECKSTRAP

A neckstrap is supplied with your camera. Attach it as shown below.

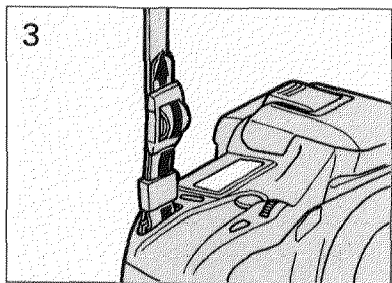
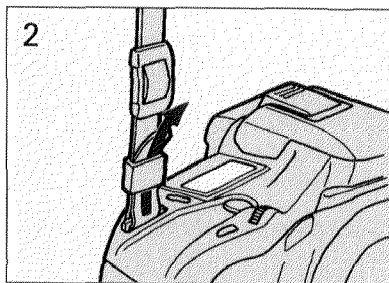
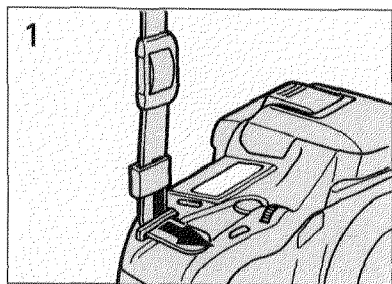

EYEPiece CAP

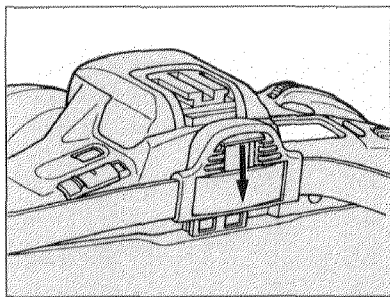
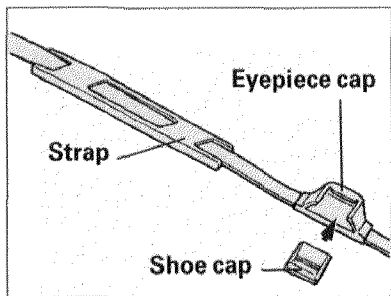

An eyepiece cap is also included on the strap. It fits over the eyepiece to prevent stray light from entering the camera and affecting the exposure during situations in which you are not looking through the viewfinder when the shutter releases (ie, self-timer photographs or bulb exposures). An accessory shoe cap protects the contacts on the camera's accessory contacts from dust and dirt. When you are using a flash or other accessory, slide the accessory shoe cap into the eyepiece cap for safekeeping.

LENS

To attach:

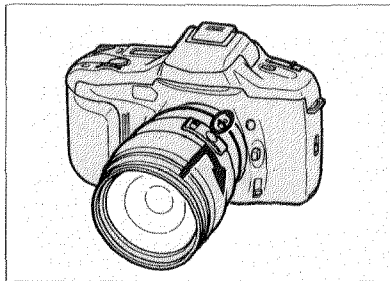
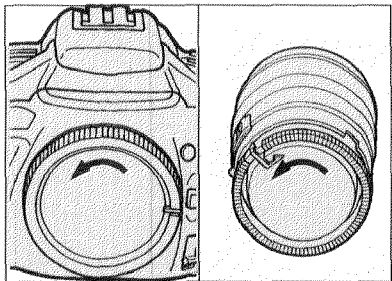

1. Remove body cap and rear lens cap as shown.
2. Align the red bead on the lens barrel with the red dot on the camera's lens mount. Gently insert the lens into the mount and turn the lens clockwise until it locks in place with a click.

● If no lens is attached to the camera, if the lens is not attached properly, or if the AZ/MZ switch on an xi-Series lens is set to MZ, "--" will appear in the body data panel and in the aperture display of the viewfinder data panel when Eye-Start activates the camera (below).

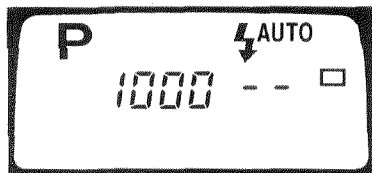

To remove:

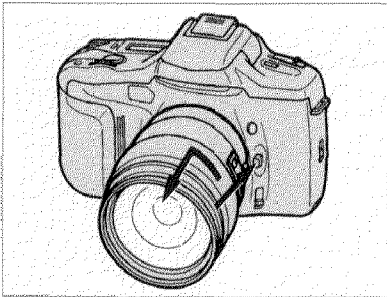

1. While pressing the lens release, turn the lens counterclockwise until it stops. Lift the lens out of the mount.
2. Immediately attach the rear cap to the lens and the body cap or another lens to the camera. This will protect the camera interior, lens contacts, and lens elements.

Be careful . . .

- Do not force the lens onto the body if it does not turn smoothly.
- Never touch anything inside the camera, especially the lens contacts and mirror.

Care of Glass Surfaces

- Never touch any lens surfaces (including the eyepiece) with your fingers. If a lens becomes dirty, first gently clean it with a lens brush. Then, if necessary, moisten a sheet of lens tissue with one drop of lens-cleaning fluid and, starting from the center of the lens, wipe the glass in a circular motion.
- Never lift the mirror or touch its surface, as this may impair its alignment or scratch its face. Dust on the mirror's surface will not affect meter readings or picture quality. If it is distracting, have the camera cleaned at an authorized Minolta service facility.

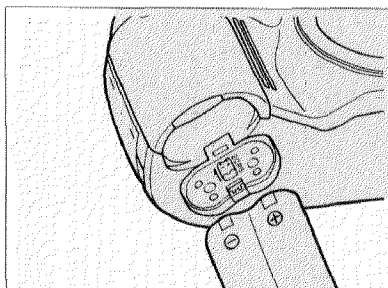
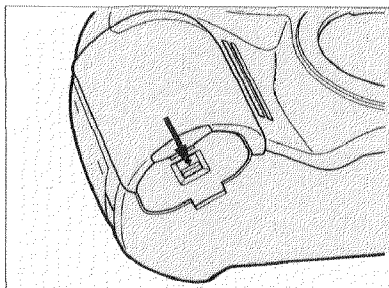

The camera uses a 6-volt 2CR5 lithium battery which supplies power for all camera operations. If you are using an xi-Series lens, the camera battery also supplies power to the lens zoom motor.

Installation

1. With the main switch in the LOCK position, slide the battery cover release in the direction indicated to open the battery cover.
2. Insert the battery according to the marks on the inside of the chamber cover.
3. Snap the cover closed.





- Sometimes it helps to wipe the battery terminals with a clean, dry cloth in order to ensure proper contact.

CAUTION

- Read and follow all warnings and instructions supplied by the battery manufacturer.
- Do not attempt to disassemble, recharge, or short-circuit the battery. Do not subject it to high temperatures or fire. The battery may explode and cause severe burns.
- Keep batteries away from children.

Battery-condition Indicators

At various times during operation, one of the following indicators will appear in the body data panel.

Display	Indication	Meaning
 The camera display shows a large 'P' in the top left, a lightning bolt icon with 'AUTO' to its right, a full battery icon, a small square icon, and a '18' with a battery symbol below it.	1. Full-battery symbol appears for 4 sec. after you turn camera on.	Power is sufficient.
 The camera display shows a large 'P' in the top left, a lightning bolt icon with 'AUTO' to its right, a low battery icon, a small square icon, and a '18' with a battery symbol below it.	2. Low-battery symbol appears for 4 seconds after you turn camera on.	Power is sufficient, but getting low. Keep a fresh battery handy.
 The camera display shows a large 'P' in the top left, a lightning bolt icon with 'AUTO' to its right, a low battery icon that is blinking, a small square icon, and a '18' with a battery symbol below it.	3. Low-battery symbol blinks while it appears with other operating indicators at any time during use.	Camera can be operated, but power is extremely low. The battery will need to be changed soon.
 The camera display shows a large 'P' in the top left, a lightning bolt icon with 'AUTO' to its right, a low battery icon, the text 'bAtt', a small square icon, and a '18' with a battery symbol below it.	4. Blinking low-battery symbol and "bAtt" appears, or no display appears at all, and shutter locks	Power is insufficient for operation. Replace the battery or check that the battery is inserted correctly.

- If no display appears when the main switch is set to ON, double-check that the battery is inserted correctly before inserting a fresh one.

Battery Performance

The 6-volt 2CR5 lithium battery should provide sufficient power for shooting approximately 50 rolls of 24-exposure film without flash or approximately 25 rolls if you use the built-in flash on 50% of the exposure. These figures are based on Minolta's standard test method using a fresh battery at 68° F (20°C). Actual battery performance will depend on how you use the camera. If you install a new battery that has been in prolonged storage, battery performance may vary.

Cold-Weather Operation

Lithium batteries provide excellent performance in cold weather. However, if you plan to shoot many rolls of film outdoors at temperatures near or below 32° F (0°C), we recommend that you carry the camera inside your coat while you are not shooting, to keep it warm. You may also want to carry a spare battery in your pocket so that you can change the camera battery if necessary. Do not discard a cold battery. After it warms up, it will regain some of its charge.

Loading Film

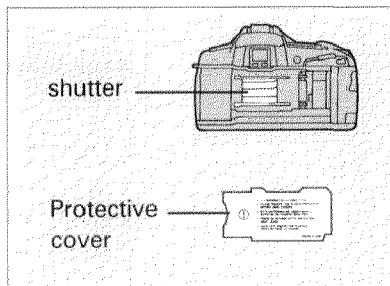
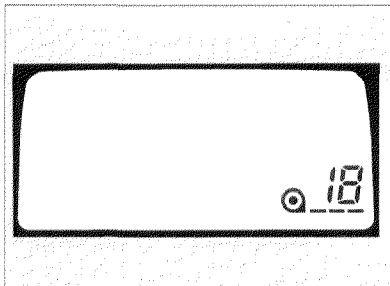

Before you load film, always check the body data panel. If the film cartridge is displayed, **do not open the back cover**. Check the film window and frame counter to verify the type of film in the camera and the number of frames remaining. (See p.20 for instructions on rewinding a partially exposed roll of film.)

- Before you load film for the first time, remove and discard the protective plastic cover over the shutter.
- Always load film in subdued or shaded light.

—NEXT PAGE—

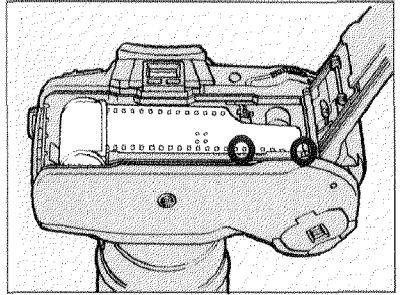
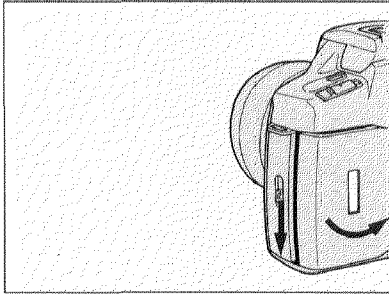

1. Open the back cover by sliding the back-cover release downward.
2. Place the film cartridge into the film chamber as shown above and extend the leader between the guide rails until the tip is just past the film-leader index. Make sure the holes in the film's lower edge are engaged by the sprocket teeth.



RIGHT

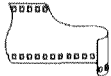

WRONG

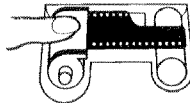

RIGHT

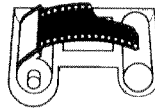

WRONG

- Make sure the film leader is shaped correctly, otherwise the film may not wind properly. Trim a torn or crimped film tip so that it looks like the correct one pictured above left.
- If the film extends too far, gently push the excess back into the cartridge.
- **NEVER TOUCH THE SHUTTER CURTAIN WITH YOUR FINGERS OR WITH THE FILM TIP.** Its precision design makes it extremely sensitive to pressure.

—NEXT PAGE—

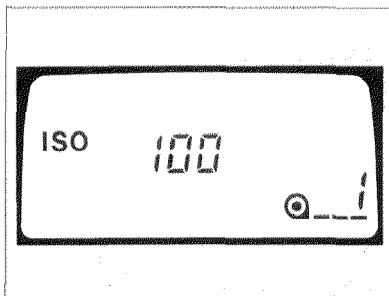
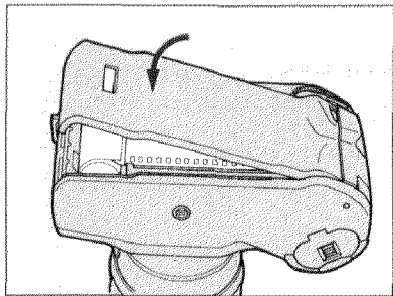

3. Close the back cover and move the main switch to **ON**. The camera will automatically advance the film to the first frame and **1** will appear in the film counter.

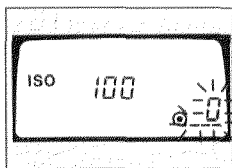

- If the film is loaded incorrectly, **0** will blink in the frame counter and the shutter will remain locked. Open the back cover and repeat steps 2 and 3.

- If you turn the main switch to ON before you load film, do not touch the grip sensor during the above procedures.

Automatic Film Speed Setting

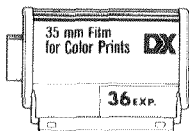

If you use DX-coded film between ISO 25 and 5000, the camera will automatically set the correct film speed. The film speed setting will be displayed in the body data panel for 4 sec. after you load the film.

Manual Film Speed Setting

If you are using a non-DX-coded film or if you wish to override the automatic setting, you must manually set the film speed. The camera will initially set non-DX-coded film to the ISO of the previous roll; initially this value is set to 100.

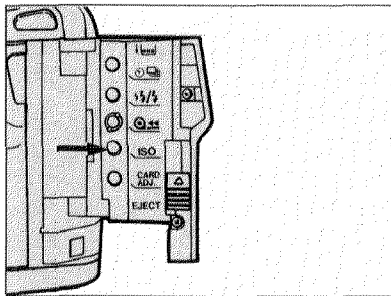
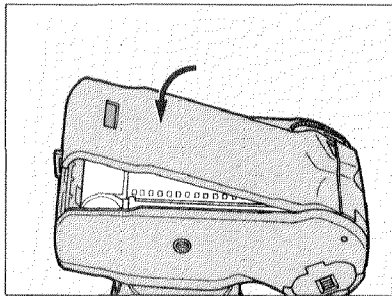

1. Load the film and close the back cover.
2. Open the card door and press the ISO button.

—NEXT PAGE—

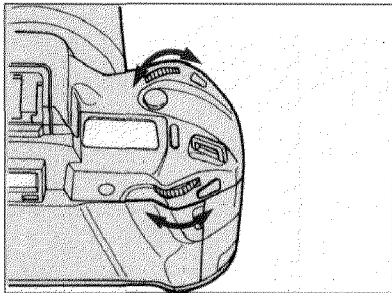

3. Turn either control dial until the desired film speed setting appears in the body data panel.

- Each click of the dials will change the film speed setting by 1/3-stop between ISO 6 and 6400.

4. Press the ISO button again to enter your selection and return to operating mode, or wait 4 sec. and the setting will be entered automatically.

- To check the film speed setting at any time during operation, press the ISO button. The ISO-speed will appear in the body data panel

- For flash exposures, Minolta recommends that you use film between ISO 25 and 1000.

Automatic Rewind

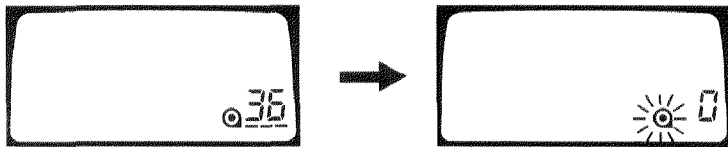

After you have exposed the last frame, the camera will automatically rewind the film. With a fresh battery, it takes about 9 sec. to rewind a 36-exposure roll, or 6 sec. for a 24-exposure roll. When the film has been completely rewound, the motor will stop and the film-cartridge symbol in the body data panel will blink to indicate that it is safe to open the camera back.

Manual Rewind

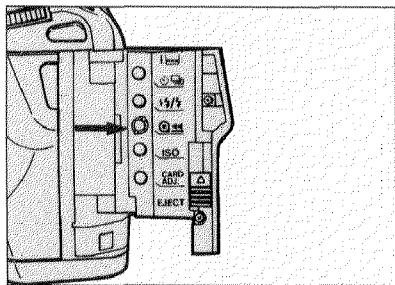

To begin rewind at any time, open the card door and press the rewind button.

- If the motor stops before the film is completely rewound, insert a fresh battery.

SIMPLE OPERATION – THE BASICS

This brief section explains the simplest way to use your new camera—with programmed autoexposure, autofocus, autoflash, and single-frame advance. Details on each of the camera's functions begins on page 38 in the section entitled "Operation in Detail".

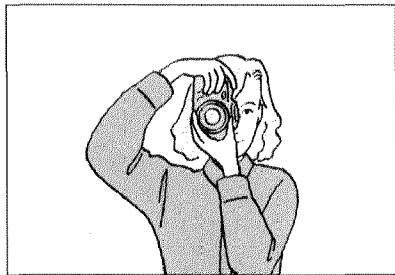
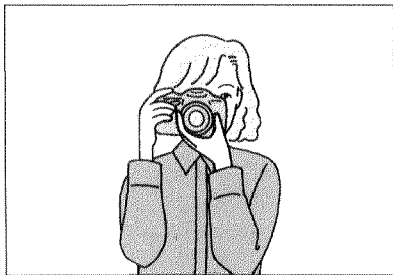

Hold the grip firmly in your right hand and use your left hand to support the camera or lens. Keep your elbows securely against your sides when shooting both horizontal and vertical pictures. Press the shutter-release button gently in a single, steady motion—never with a quick jab. Always keep the camera strap around your neck or wound around one wrist.

- When you pick up the camera, make sure you touch the grip sensor. Otherwise, Eye-Start will not function.
- Do not touch the focusing ring of an AF lens or the end of the lens barrel of an xi-Series Autozoom lens.
- Do not block the AF illuminator when you are using autofocus.

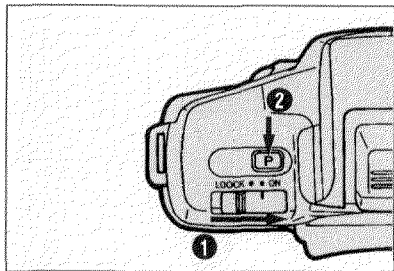

1. Slide the main switch to **ON** and press the program-reset button to set full-automatic operation.

● Pressing the program-reset button sets the camera to programmed autoexposure mode, honeycomb-pattern metering, autofocus, single-frame film advance, $+/- 0.0$ exposure compensation, wide autofocus area, and auto switchover flash. Many of these default positions can be changed with the Customized Function Card-xi.

—NEXT PAGE—

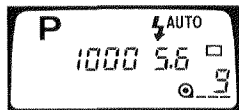

2. Hold the camera as described on p.22.
 3. Look through the eyepiece, place your subject somewhere within the autofocus area, and press the shutter-release button down to take the picture.
 4. After the exposure has been made, the camera will automatically advance the film to the next frame and increase the film counter by one.
- The focus signal will light in the viewfinder data panel when your subject is in focus. See p.27 for a list of focus signals.
 - If you do not touch the grip sensor you must activate AF and AE by pressing the shutter-release button partway down. Again, the in-focus signal will light when the camera has focused on a subject.
 - If the focus signal blinks in the viewfinder data panel, you must focus on something else that is the same distance from you as your subject or else focus the lens manually. Refer to p.43 for more information.

CAMERA-SHAKE WARNING



When your subject or scene is too dark to allow a clear hand-held photograph, the camera-shake warning will blink in the viewfinder data panel. The built-in flash will pop-up automatically, if it is required, when you press the shutter-release button partway down and will fire when you take the picture. You should also consider using a tripod.

- More information on flash operation in all exposure modes can be found beginning on p.62.

Autofocus (AF)

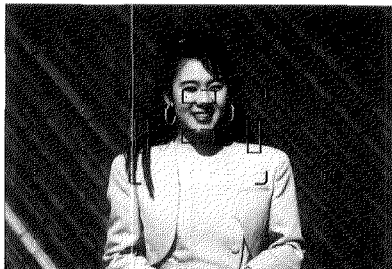

The autofocus system uses expert programming and fuzzy logic to determine which of the AF sensors is detecting your main subject. The camera's ultra-wide AF area has four sensors—two vertical and two horizontal. When you hold the camera horizontally, all four sensors are active; when you hold the camera vertically, the top horizontal sensor shuts off and the AF area changes to its vertical mode.

Focus Signals





When the camera is activated, either by Eyestart or by pressing the shutter-release button partway down, the AF system immediately begins evaluating the scene to determine the location of your subject within the frame. One of the following focus signals will be displayed in the viewfinder data panel:

	Continuous AF mode/focus is confirmed
	Focus is locked
() or ● [blinking]	Focus cannot be confirmed.

- No indicator will be displayed while the lens is focusing.
- If your subject is moving, the camera will automatically enter continuous autofocus mode. In this mode, the autofocus system will repeatedly check and update focus until you press the shutter-release button all the way down. At that time, the camera will predict where the subject will be when the shutter actually makes the exposure and will set the lens to this point so that even high-speed subjects shot in continuous drive mode will remain in focus. (see Focus Lock, next page)
- If your subject is stationary when Eye-start first activates the autofocus system, the camera will enter continuous mode. It will remain in continuous mode if your subject moves before you press the shutter-release button partway down. Focus will lock if it remains stationary.
- In autofocus mode, if focus cannot be confirmed, the shutter will not release.



If, as a result of the composition or framing you have chosen, your subject falls outside the main AF area, use focus lock to lock focus on it, then recompose the scene as desired.

1. Place your subject in the center of the AF area and press the shutter button partway down.
 - Wait for the focus signal to change from  to .
2. Hold the shutter button in this position, recompose the picture, and press the shutter button all the way down to take the picture.



P mode is designed to be the camera's primary exposure mode and is ideally suited for almost all situations. Expert Program Selection analyzes the scene, taking into account subject size, motion, and magnification as well as lens focal length, and sets both the shutter speed and aperture accordingly. It is able to recognize many different photographic situations, from landscapes to close-ups, portraits to action shots, and will optimize the exposure settings based on the particular requirements of the situation at hand. There is no single program line for each focal length, and no special modes to set manually for different situations. Creative Program Control lets you quickly change the programmed exposure settings to obtain a desired effect in your photographs.

—NEXT PAGE—

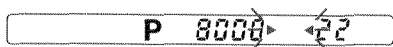
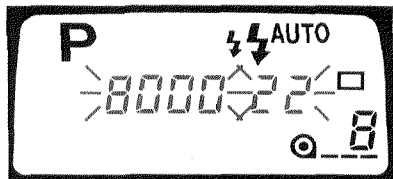

- If the aperture and shutter speed displays blink in the viewfinder and body data panels, then the required exposure settings are beyond the coupling range of the camera and lens.
- If the metering indicators ► ◀ blink in the viewfinder data panel, the lighting is beyond the range of available aperture and shutter speeds. In bright light, attach a neutral density filter.

PA/PS: CREATIVE PROGRAM CONTROL

As already mentioned, Expert Program Selection will determine the best combination of shutter speed and aperture for almost any scene or situation. If, however, you would like to use a different shutter speed or aperture, the dual-dial control system makes it quick and easy for you to make the desired changes. Furthermore, as you change the aperture or shutter speed, the image control index in the bottom of the viewfinder will show you what effects your adjustments will have on the final image.

- If  appears in the viewfinder data panel, Creative Program Control will not function until you manually cancel the flash or until the flash is no longer necessary.
- The built-in or an attached flash will not function in PA or PS. If you press the flash control button either to pop-up the built-in flash or to manually fire an accessory flash, the camera will return to P mode.

PA

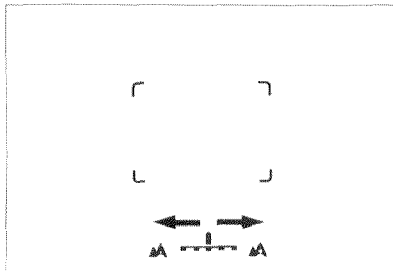
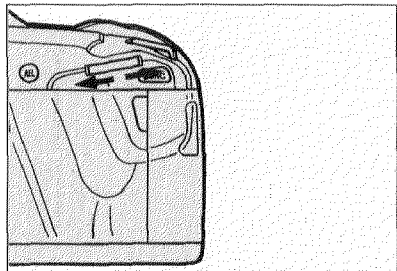

In both P mode and PA, the depth index at the bottom of the viewfinder screen will show roughly how in-focus the background will appear in your final print. If the indicator is all the way to the right, everything from your main subject to infinity will be in focus. If the indicator is to the left, only your subject will be sharp.

When you move the rear control dial, you can change the aperture setting of the programmed exposure and, if the proper shutter speed is available, the camera will maintain a correct exposure. At the same time, the indicator in the depth index will move to show you approximately how your changes will effect your photo.

- If you do not touch any of the camera controls for 30 sec., the camera will return to P mode automatically.
- The shutter speed display will blink if the required speed is beyond the camera's range. If "8000" blinks, move the indicator to the right; if "30" blinks, move the indicator to the left.
- If the metering indicators ► ◀ blink in the viewfinder data panel, the light level is beyond the coupling range of the camera and lens. In bright light, attach a neutral density filter; in low light, return to P mode.

—NEXT PAGE—

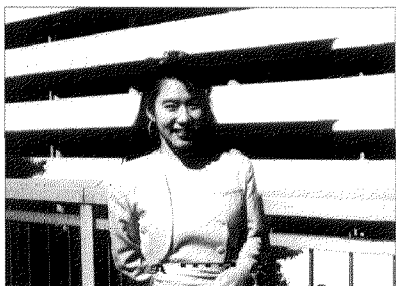
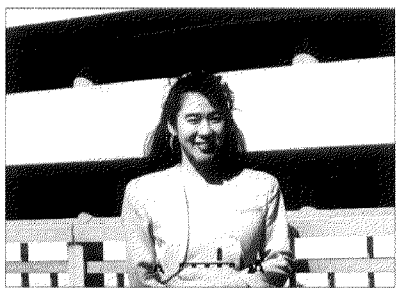
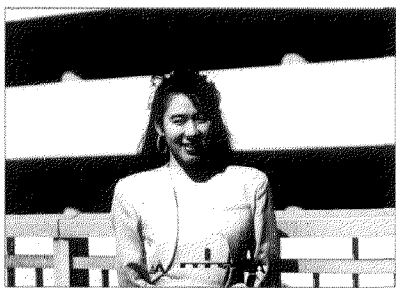
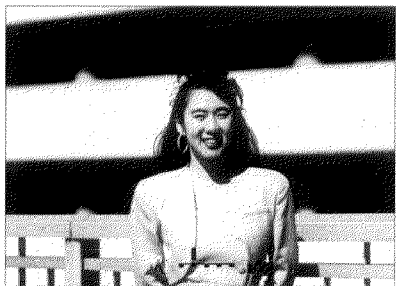
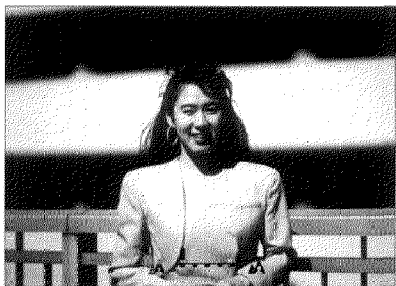

—NEXT PAGE—

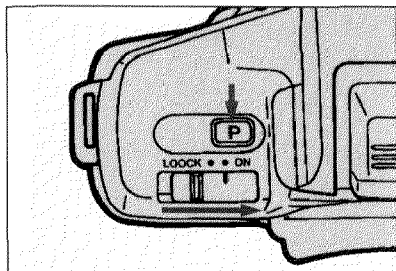
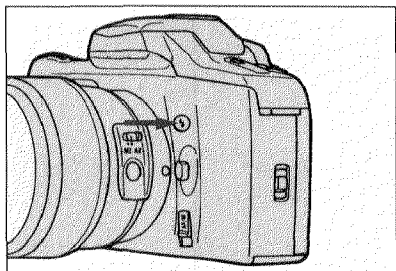

- To return to P mode, press the program re-set button; to return to P mode and keep any changes you have made to the camera's operation, press the flash pop-up button.
- The flash will not fire automatically while you are in PA.
- To turn the depth index off, press and hold the program re-set button down and move the main switch back to ON. Repeat to turn the index on again.
- Most lenses will not use all the positions on the index.
- The approximate depth which is indicated may be incorrect if the background is very close to the subject.
- If you move the front dial, the camera will change to Ps. See next section for more information.
- For more information on aperture and depth, see p.84.

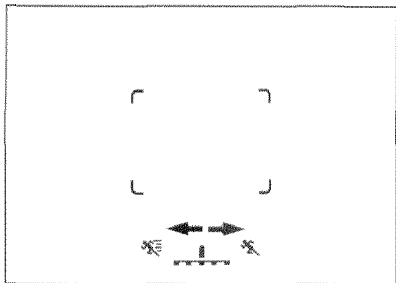
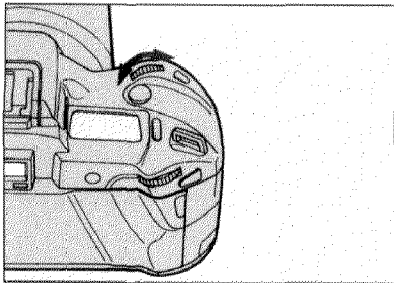

In P mode, if you move the front control dial, the depth index will be replaced by the action index. It shows the approximate amount of action-stopping ability the current shutter speed setting will provide for the subject which the camera currently detects. If you move the indicator to the right by turning the front dial to the right, then the camera will set a faster shutter speed and will adjust the aperture to maintain a correct exposure; turning the dial to the left will provide slower shutter speeds.

- To return to P mode, press the program re-set button; or, to return to P mode and keep any changes you have made to the camera's operation, press the flash pop-up button.
- If you do not touch any controls for 30 sec., the camera will return to P mode automatically.
- If the aperture display blinks, the aperture required for a correct exposure is not available. If the lens' largest f-number blinks, move the indicator to the right; if the smallest f-number blinks, move it to the left.
- If the metering indicators ► ◀ blink in the viewfinder data panel, the light level is beyond the coupling range of the camera and lens. In bright light, attach a neutral density filter; in low light, return to P mode.
- The flash will not fire while you are in Ps.

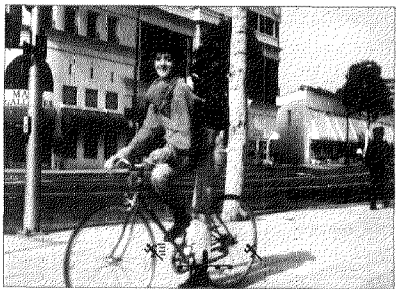

—NEXT PAGE—

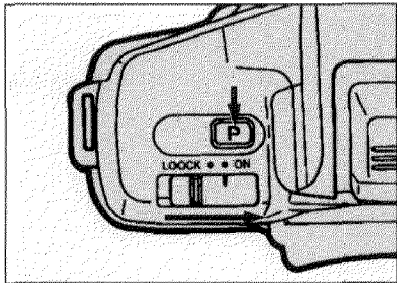
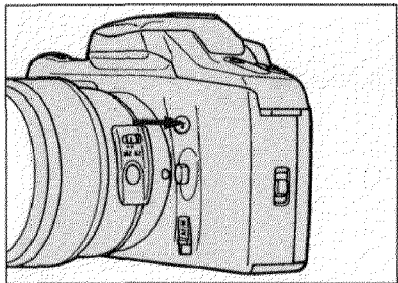

- To turn off the action index, press and hold the program re-set button down and move the main switch back to ON. Repeat to turn the index on again.
- If you move the rear dial, the camera will enter PA. See previous section for more information.
- For more information on subject motion and shutter speed, see p.87.
- The action index should only be used with moving subjects. It will not provide relevant information about stationary subjects. The camera-shake warning will be more helpful in this case.

OPERATIONS IN DETAIL

MAIN SWITCH/EYESTART

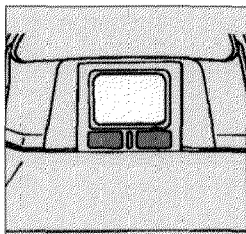
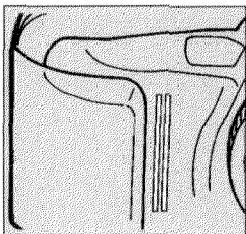
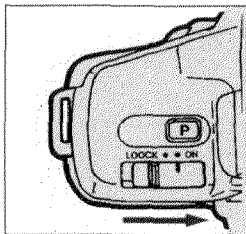

When you move the main switch to **ON**, the body data panel and the grip sensor activate. When you then touch the grip sensor, the eyepiece sensor is activated. This sensor then immediately activates autofocus, autoexposure, and, if you are using an xi-Series Autozoom lens, auto stand-by zoom when it detects an object near the viewfinder. By the time you frame your subject, therefore, the camera has performed many of its set-up operations and is ready to make an exposure. The shutter-speed and aperture displays in the body data panel will disappear 4 sec. later.

FOCUSING DETAILS

Autofocus Illuminator

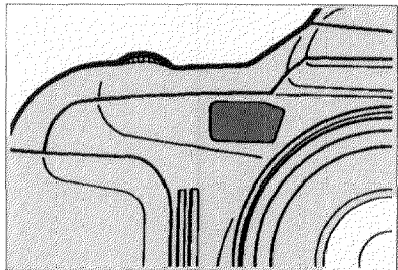

In low-light or when subject contrast is too low to be read by the autofocus sensors, the AF illuminator will activate. It projects a pattern of lines onto your subject which the AF sensors can then detect.

- Be careful not to obstruct the AF illuminator while you are holding the camera.
- The AF illuminator will not work if the focal length of the lens you are using is 300mm or longer (excluding AF Zoom 100–300/4.5–5.6 and AF Zoom 75–300/4.5–5.6), or if you are using the 3X–1X Macro Zoom.

Local AF Area Selection

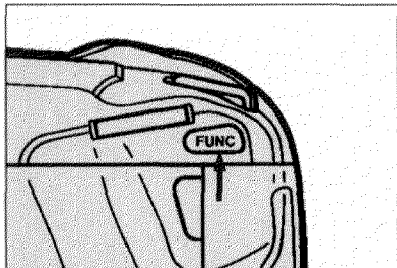

If you want to use a specific AF sensor, you can manually override the selection sequence and use only one of the four sensors.

1. Press the dial function selector twice; $\frac{[\cdot]}{[\text{ON}]}$ will appear in the viewfinder.

—NEXT PAGE—

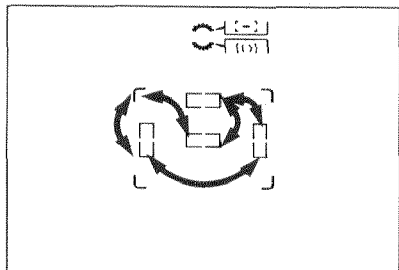
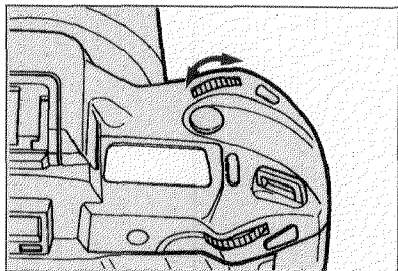

2. Turn the front control dial until the AF sensor you want appears in the viewfinder or the body data panel.
 3. Press the shutter-release button partway down to enter the area you have chosen and return to normal operating mode, or wait 4 sec. and your choice will be entered automatically.
- Autofocus does not function while you are selecting a local AF area.

Special Focusing Situations

The camera's autofocus system will produce sharp pictures in nearly any situation. In the cases described below, however, it may be difficult or impossible for the camera to autofocus properly – manual focusing may be necessary.

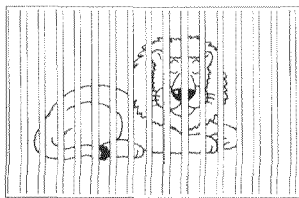

If two subjects at different distances overlap within the focusing frame

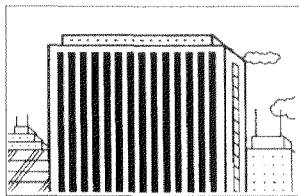

If a subject composed of alternating light and dark lines completely fills the focusing frame

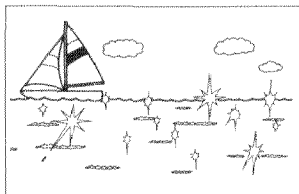

On very bright subjects
On low-contrast subjects

- You can also lock focus on another object of equal distance and then recompose your picture (see p. 28).

Manual Focus

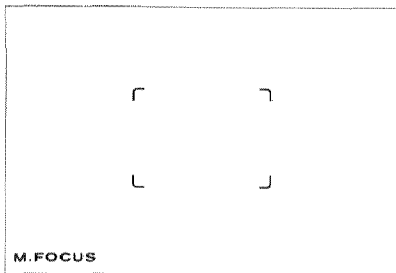
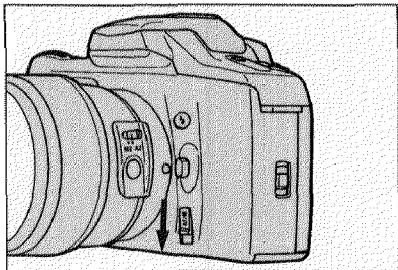

To manually focus the lens:

1. Slide the focus mode switch down to set the camera to manual focus mode.

- "M. FOCUS" will appear in the lower left corner of the viewfinder.

2. If you are using an AF lens, turn the focusing ring until the subject appears sharp. With an xi-Series lens, pull and turn the zoom ring. For more information, refer to the lens manual.

- When your subject comes into focus, the green in-focus signal will light.

- In manual focus mode, the shutter will release even if the subject is not in focus.

—NEXT PAGE—

3. To return to autofocus mode, slide the focus mode switch down.

- Pressing the program re-set button will also return the camera to autofocus mode, but this will also change all of the programmable functions to their default settings.

EXPOSURE DETAILS

The camera has four exposure modes: programmed autoexposure (P), aperture-priority autoexposure (A), shutter-priority autoexposure (S), and manual exposure (M).

Changing Exposure Mode

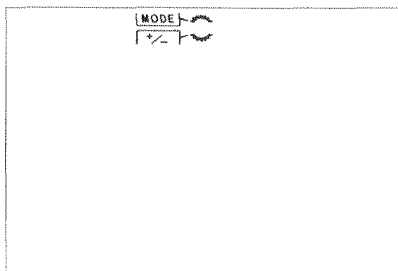
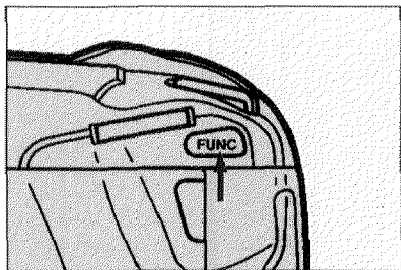

1. Press the dial function selector button once;  will appear in the viewfinder.

—NEXT PAGE—

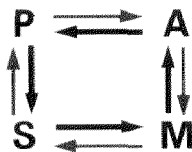
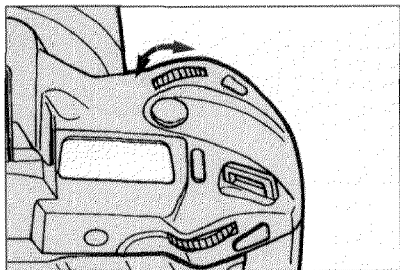

2. Turn the front control dial until the exposure mode you want appears in the body or the viewfinder data panel.

- The modes will cycle in the sequence shown above.
- In M mode, M does not appear in the viewfinder data panel.

3. Press the shutter-release button partway down to enter the mode you have chosen and return to normal operating mode; or wait 4 sec. for it to be entered automatically.

- Pressing the program re-set button returns the camera to **P** mode and re-sets the camera's programmable functions to their default settings.

Aperture Priority (A)

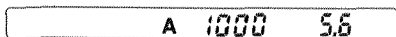
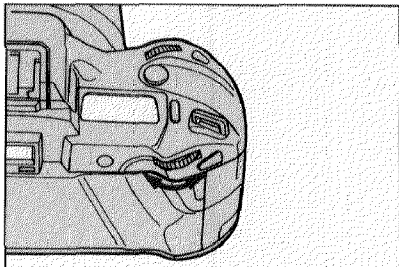

In aperture priority (A) mode, you set the aperture you want and, if the shutter speed is available, the camera will automatically maintain the correct exposure.

1. Refer to p.46 (Changing Exposure Mode) and select **A**.
 - The depth index will appear in the lower part of the viewfinder screen and the indicator will show the approximate depth that the current aperture will provide.
2. To set the aperture, turn the rear control dial to the left or right.

The aperture display in the body and viewfinder data panels will change in 1/2-stop increments with each click of the dial. The depth index's indicator will also move to reflect the changes in the depth that different apertures will provide. When the indicator is all the way to the right, the aperture that is set will provide maximum depth of field. As you open up to larger apertures (smaller f/numbers), the indicator will move toward the graphic on the left, to indicate a gradual loss of depth in the picture.

—NEXT PAGE—

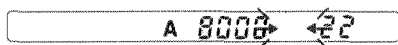
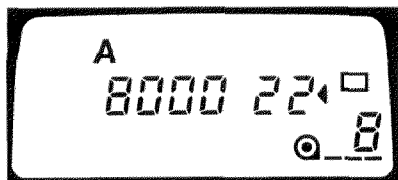

- Available apertures and are limited to those within the range indicated on the lens you are using.
- The shutter speed display will blink if the required speed is beyond the range of the camera. If "8000" blinks, set a smaller aperture; if "30" blinks, set a larger aperture.
- If the metering indicators ► ◀ blink in the viewfinder data panel, the lighting is beyond the range of available apertures and shutter speeds. In bright light, attach a neutral density filter; in low light use a faster lens or faster film.

Shutter Priority (S)

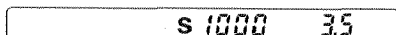
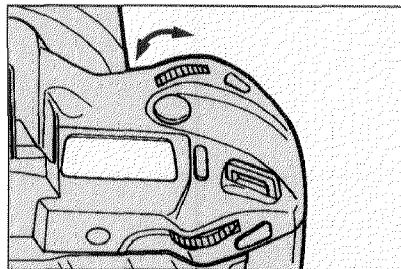

This exposure mode lets you select a shutter speed and, if the lens you are using allows, the camera will automatically set the correct aperture to ensure a proper exposure.

1. Refer to p.46 (Changing Exposure Mode) and select **S**.

● The action index will appear in the lower part of the viewfinder screen and the indicator will show the approximate amount of action-stopping the current shutter will provide.

2. To set the shutter speed, turn the front control dial.

The shutter speed display in the body and viewfinder data panels will change in half-stop increments with each click of the dial. The indicator on the action index will also move to illustrate the changes that different shutter speeds will have on your photograph.

When the indicator is all the way to the right (towards the stop- action runner), then the shutter speed which you have set will stop the action of your subject. As you set slower shutter speeds, the indicator will move to the left, towards the picture of the blurred runner.

—NEXT PAGE—

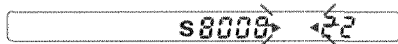
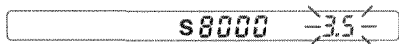

- If the aperture display blinks, the aperture required for a correct exposure at the shutter speed you have selected is not available. If the lens' minimum aperture blinks, set a faster shutter speed; if the maximum aperture blinks, set a slower shutter speed
- If the metering indicators ► ◀ blink in the viewfinder data panel, the light level is beyond the coupling range of the camera and lens. In bright light, attach a neutral density filter; in low light, use a faster lens or faster film.
- You cannot select BULB in S mode. See next section.

Manual Exposure (M)

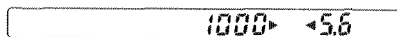
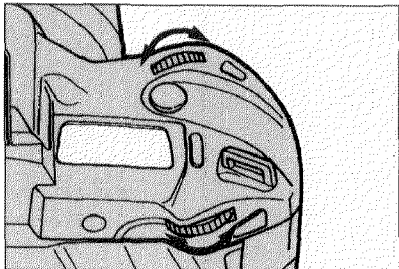

Manual mode should be used whenever you want full creative control over the exposure settings. In this mode, you select the shutter speed and aperture and the camera will tell you whether your settings will provide an over-, under-, or correctly-exposed picture.

1. Refer to p.46 (Changing Exposure Mode) and select **M**.
 2. To set the shutter speed, turn the front control dial to the right for faster shutter speeds or to the left for slower. To set the aperture, turn the rear control dial to the right for smaller apertures or to the left for larger.
- Both The shutter speed and aperture displays will change in half-stop increments.

1000▶ ◀5.6	Exposure is set correctly.
750▶ 5.6	Over exposure
1500 ◀5.6	Under exposure
8000▶ ◀22	The light level is beyond the meter's range.

In manual mode, the above displays in the viewfinder data panel will relate information regarding your settings.

METERING MODES

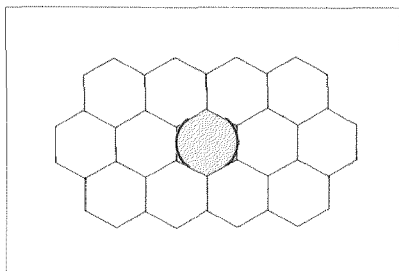
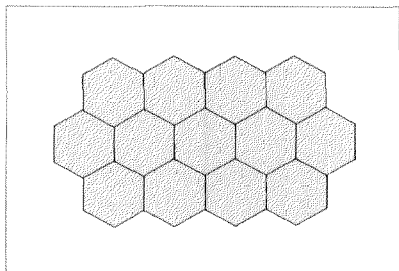

The camera's standard metering mode is AF-Integrated, 14-Segment, Honeycomb-Pattern Metering, which will provide the correct exposure in almost all situations. Spot metering can also be manually selected, in which case, the center segment in the honeycomb pattern is used exclusively to measure the subject's brightness.

To use spot metering:

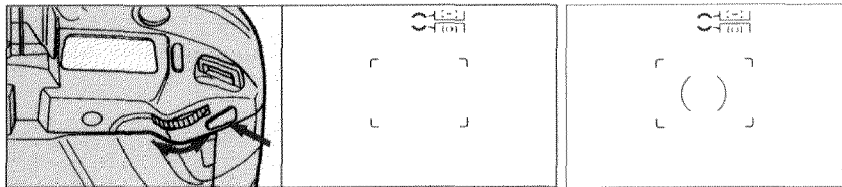

1. Press the dial function selector twice; $\frac{1}{(M)}$ will appear in the viewfinder.
 2. Turn the rear dial one click-stop in either direction to select spot metering.
 3. Press the shutter release button partway down to enter your selection and return to normal operating mode or wait 4 sec. for it to be entered automatically.
 4. Center the spot metering circle in the viewfinder over the area that you want to meter.
 5. Press and hold the AE lock button, recompose the scene, and press the shutter release button all the way down to take the picture.
- If the area you want to meter is not the same distance from the camera as where you want to focus, first lock focus on your subject. Then position the spot circle over the area to be metered, press and hold the AE lock button, recompose the scene as desired, and press the shutter-release button all the way down.
 - In manual exposure mode, spot metering will only provide a meter reading of the area within the center circle. The camera will not automatically set this reading.

To return to honeycomb-pattern metering, repeat the selection procedure and turn the rear dial one click-stop in either direction.

- Pressing the program re-set button will return to AF-integrated 14-segment honeycomb multi-pattern metering, but will also return the camera's other programmable functions to their default settings.

EXPOSURE COMPENSATION

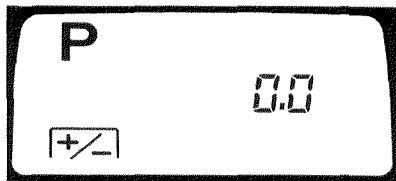
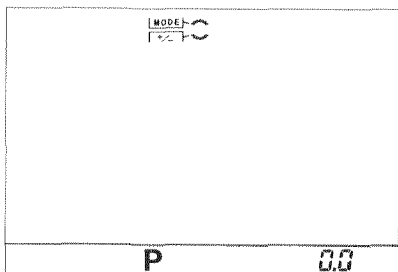

This function enables you to bias the camera's exposure calculation up to 4 stops. Over or under the normally metered selection.

To set:

1. Press the dial function selector button once;  will appear in the viewfinder.
2. Turn the rear control dial until the compensation figure you want appears in the viewfinder and body data panels.
3. Press the shutter release button partway down to enter the exposure factor and return to normal operating mode or wait 4 sec. for your selection to be entered automatically. The exposure which appears in the viewfinder and body data panels will include this factor.

—NEXT PAGE—

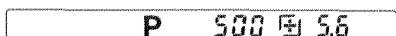
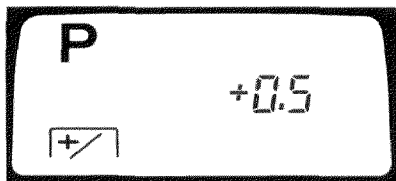

- After you enter the compensation factor, the number will disappear, but “+” or “-” will remain as a reminder that an adjustment has been made. To check the amount of compensation at any time, press the dial function selector once. The compensation figure will again appear in the viewfinder and body data panels.

To cancel the compensation, set 0.0 adjustment and return to normal operating mode.

- Pressing the program re-set button will cancel any exposure compensation and return all the camera's programmable functions to their default settings.

AE LOCK

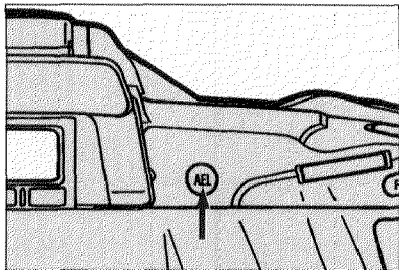

P 500 5.6 AEL

To lock the exposure system independently of the autofocus system, position your subject in the viewfinder and press the AE lock button; AEL will appear in the viewfinder data panel. Hold the button in as you recompose and take the picture.

- If you release the AE lock button before you take the picture, the exposure system will re-evaluate the scene and continue functioning as normal.

SELF-TIMER

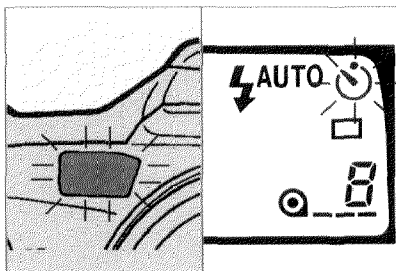
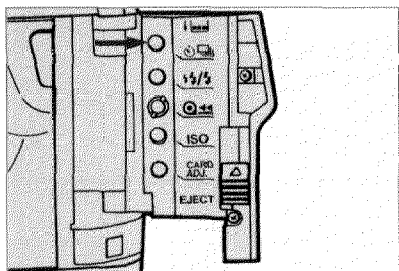

The electronic self-timer will delay release of the shutter about 10 sec. after you press the shutter-release button.

To set:

1. Open the card door and press the self-timer/drive-mode button once. The self-timer indicator will appear in the body data panel.
 2. Compose your scene and attach the eyepiece cap.
 3. Press the shutter-release button all the way down to start the timer.
- The AF illuminator will blink twice per second until the shutter releases.
 - The self-timer can be stopped during countdown by moving the main switch to LOCK. To restart the timer from the beginning of its countdown, move the main switch back to ON and press the shutter-release button again. To cancel the self-timer, move the main switch back to ON and press the *self-timer/drive-mode button*.
 - The self-timer automatically switches off after shutter-release. To make another exposure with the self-timer, repeat steps 1 – 3.

BULB: LONG EXPOSURES

To make bulb exposures:

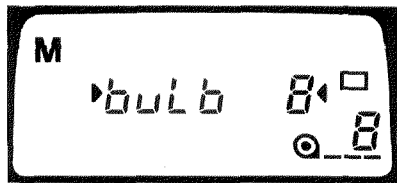
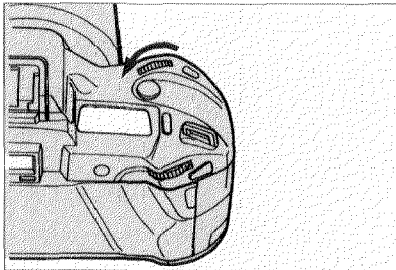

1. Mount the camera on a tripod.
2. Refer to p.46 and set the exposure mode to manual (M).
3. Turn the front control dial to the right until **bulb** appears in the body data panel. Turn the rear dial to set the aperture.
4. Compose your scene and focus the lens.
 - If the scene is too dark, autofocus may not function. Slide the focus mode switch down and focus the lens manually.

— NEXT PAGE —

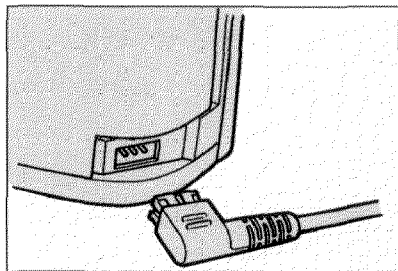
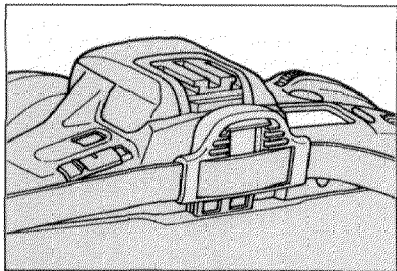

5. Attach the eyepiece cap.

6. To take the picture, press the shutter-release button and hold it down for the duration of the exposure. The shutter will remain open until you release it.

- To prevent camera shake, attach Remote Cord RC-1000 S/L. Open the card door, remove the remote-control terminal cover, and insert the remote cord's plug into the terminal. The shutter will remain open as long as you hold the remote control button down.

- When "--" appears in the aperture display of the body data panel (eg., when a lens is not attached), the shutter will lock if film is in the camera to prevent accidental exposures. If you want to release shutter under such conditions (eg., when the camera is attached to a telescope), contact your nearest authorized Minolta Service facility.

FLASH SYSTEM

FLASH MODES

 **AUTO** : Autoflash

 **AUTO** : Autoflash with pre-flash

OFF  : Flash cancel (in P mode)

 : Remote/Wireless off-camera TTL flash (blinking alternately)

The built-in flash operates in four different modes: single-burst, single-burst with pre-flash, flash cancel, and as a remote trigger for an off-camera flash. Autoflash is the camera's standard mode. In pre-flash mode, the flash will fire a small burst before the exposure in order to reduce red-eye in portraits. Flash cancel allows you to take pictures using only available light. Remote/Wireless off-camera flash control is explained beginning on p.70.

CAUTION

The lens hood should not be used when taking pictures with the camera's built-in flash since vignetting will result.

To set the flash mode:

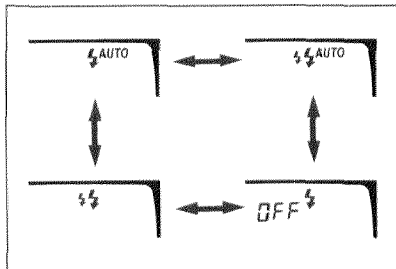
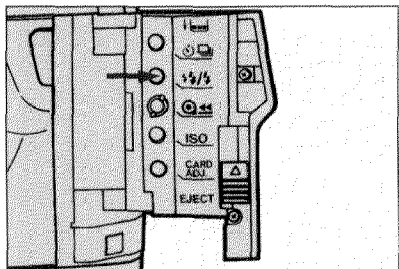



1. Open the card door and press the flash mode button.
 2. Turn the front or rear dial. The flash mode indicators will appear in the body data panel in the sequence shown above.
 3. Press the flash mode button again to enter the mode you have selected.
- Flash cancel in P mode can be selected only when the flash is down.

PROGRAM MODE FLASH OPERATION

The camera uses an advanced flash control system to provide correct flash exposures in P mode whenever it is required. The camera's TTL (through-the-lens) flash metering system controls the flash output to ensure a proper exposure.

Viewfinder Signals and Flash Control

As soon as the camera detects that flash will be required, the flash-on indicator  appears in the viewfinder data panel. The flash-ready indicator  will light when the flash is fully charged. When you press the shutter release partway down, the flash will pop-up, and it will fire when you take the picture. After you release the shutter, if the flash output was sufficient to provide a correct exposure, the flash-ready signal will blink. The flash can also be forced to fire at any time by pressing and holding the flash pop-up button while you take the picture.

- The shutter will lock while the built-in flash is charging to prevent underexposure.
- If the flash pops up and you press it back down, it will remain off until you take the camera away from your eye and wait for Eye-Start to turn off the metering system (aperture and shutter speed will disappear from the body data panel). To resume normal autoflash operation without taking the camera away from your eye, press the flash pop-up button.
- If you press the flash pop-up button and do not keep it pressed down, the flash will pop-up, but will only fire when necessary.
- The built-in flash or an accessory flash will not fire while the camera is set in Creative Program Control (PA/PS).









A, S, AND M MODE FLASH

In A, S, or M mode if the flash is down it will not fire; if the flash is up, it will fire each time you press the shutter-release button. To raise the flash, press the flash pop-up button; it will not pop-up automatically in any of these exposure modes. Single-burst, single-burst with pre-flash, flash cancel, and remote off-camera control can all be selected in any of these exposure modes, as well.

In S mode, the shutter speed and aperture will be set automatically by the camera. In A and M mode, you can set any aperture within the lens' range. In M mode, you can select any shutter speed between 1/200 sec. and 30 sec., as well as BULB.

—NEXT PAGE—

EXPOSURE MODE	FLASH POP-UP	BURST
P MODE	Auto	Auto
A MODE	Manual with pop-up button	UP; burst DOV
S MODE		
M MODE		

	FLASH MODE	AVAILABLE SHUTTER SPEED
	 AUTO; Auto flash  AUTO; Auto with pre-flash OFF  ; flash cancel  ; remote/wireless off  camera flash	1/200 to 30sec. (set automatically)
V;off V;off	 ; single-burst	1/200 sec.
	 ; single with pre-flash	1/200 to 30sec. (set automatically)
	 ; remote/wireless off camera flash	1/200 to 30sec. and bulb

SLOW-SHUTTER SYNC FLASH

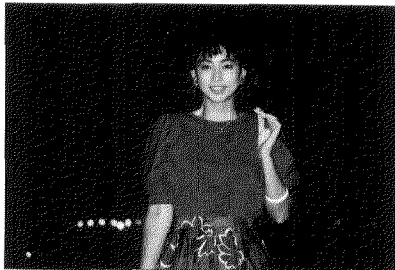

The slow-sync shutter option will set a slower shutter speed to increase the background or ambient lighting exposure in a flash picture. Flash output will be decreased automatically to maintain a correct exposure of your subject.

1. Frame your subject and press and hold the shutter-release button partway down.
2. Press and hold the AE lock button.

—NEXT PAGE—

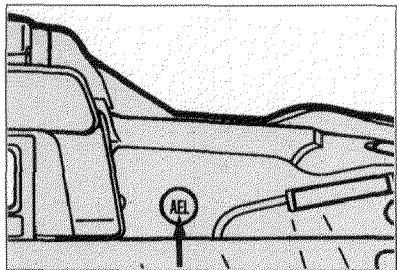

3. Continue to hold the AE lock button and press the shutter-release button down completely.

- If the background is bright or a large aperture is set, the shutter speed may not be reduced.
- The flash-ready indicator in the viewfinder data panel will blink rapidly if the flash output was sufficient to provide a correct exposure.
- If, after you press the AE lock button, the shutter speed becomes too slow to allow sharp, hand-held pictures, use a tripod.

REMOTE/WIRELESS OFF-CAMERA FLASH CONTROL

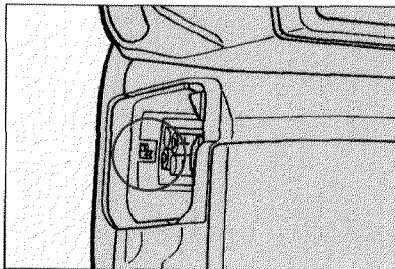
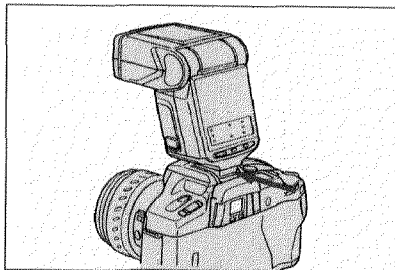

When used with specified xi flash units, this camera offers you the flexibility of remote/wireless off-camera flash control with TTL flash metering. The flash unit has more than one control channel so that if you are working near someone who is using a similar set-up, you will not interfere with each other. The flash must be mounted on the camera when you change the control channel.

1. Attach the flash to the camera and turn it on.
 - To change the control channel, move the control channel selector in the battery chamber of the flash to **1** or **2**.
2. Press the flash mode button in the card door, turn either the front or rear control dial, and select remote off camera flash mode.
3. Remove the flash and position it according to the table with its AF illuminator pointing at the subject.

— NEXT PAGE —

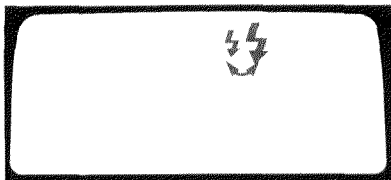
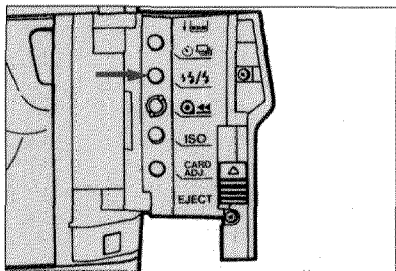

- The camera should be 1m to 5m (3 ft. to 16 ft.) from the subject.
- The off-camera flash may not detect the control signals if it is placed behind the subject.

FLASH RANGE (m/ft)		
Film speed Aperture	ISO100 m/ft	ISO400 m/ft
1.4	2.0 – 5.0/6 – 16	4.0 – 5.0/13 – 16
2.0	1.4 – 5.0/4 – 16	2.8 – 5.0/9 – 16
2.8	1.0 – 5.0/3 – 16	2.0 – 5.0/6 – 16
4.0	0.7 – 4.5/2 – 14	1.4 – 5.0/4 – 16
5.6	0.5 – 3.2/1 – 10	1.0 – 5.0/3 – 16
8.0	0.4 – 2.3/1 – 7	0.7 – 4.5/2 – 14
11.0	0.4 – 1.6/1 – 5	0.5 – 3.2/1 – 10

– NEXT PAGE –

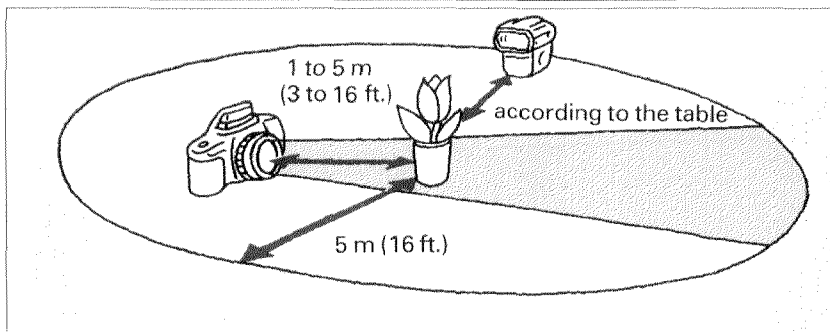

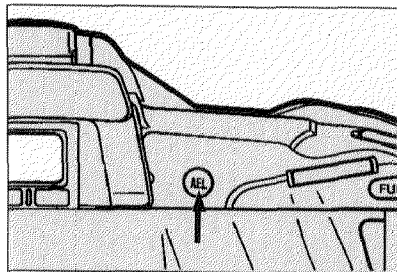
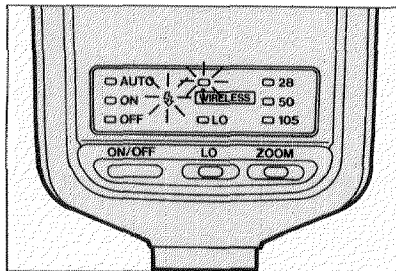

4. Wait until both the off-camera flash and built-in flash are charged.
 - In remote mode, the off-camera flash's AF illuminator and flash-ready signal will blink when the flash is charged. The flash-ready signal in the viewfinder will blink when the built-in flash is charged.
5. Press the AE lock button to test-fire the off-camera flash and wait again until both flashes are fully charged.
6. Take the picture.
 - The flash-ready indicator in viewfinder data panel will blink rapidly if the flash output was sufficient to provide a correct exposure.

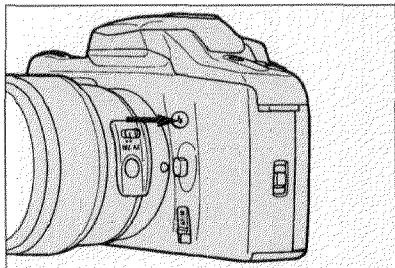
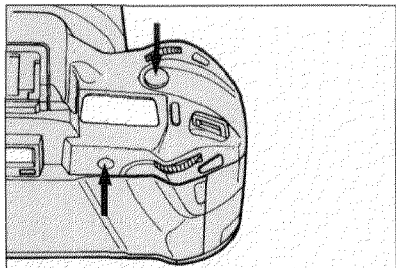

Remote/Wireless slow-shutter sync

In remote slow-shutter sync mode, the camera sets a slow shutter speed and reduce the flash exposure to maintain a correct exposure. Operation is the same as it is with the built-in or an attached flash (explained on p.68).

- When you press the AE lock button, the off-camera flash will fire a test burst. Wait for the flash to recharge and take the picture. Do not release the AE lock button until after you have taken the picture.

Ratio control

In remote mode, the built-in flash normally only controls the off-camera flash without effecting the overall exposure. The built-in flash can, however, be set to fire during the exposure so that it provides some fill lighting on your subject. Press and hold the flash pop-up button while you take the picture. The off-camera flash will provide 2/3 of the exposure and the built-in flash will add the remaining 1/3.

FILM DRIVE

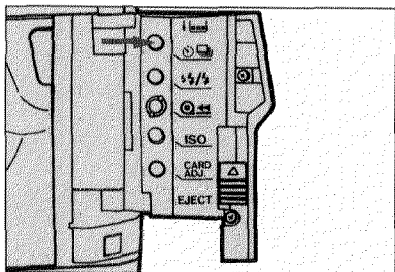

The camera has three film-drive modes. In single-frame advance mode, the camera makes one exposure and advances the film one frame each time you press the shutter-release button. In high-speed continuous mode (H), the film is advanced at approximately 4 frames per second for long as you hold the shutter-release button down; low-speed continuous mode (L) will provide up to 2 frames per second. When you operate the camera in either low- or high-speed continuous and autofocus mode, the focus setting will be checked and adjusted between each exposure to ensure that moving subjects remain sharply focused.

To select the film-drive mode:

1. Open the card door.
2. Press the self-timer/drive-mode button until the indicator for the mode you want appears in the body data panel.

—NEXT PAGE—

Sequence

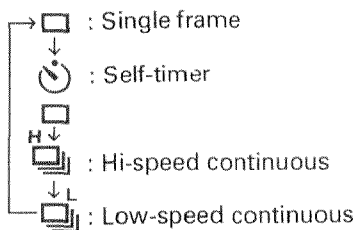

3. To return to single-frame advance, press the self-timer/drive-mode button until it appears in the data panel.

- Pressing the program re-set button will return the camera to single-frame advance and return all of the camera's programmable functions to their default settings.

With an xi-Series Autozoom lens, the camera's automatic control also extends to zooming the lens. This speeds operation of the camera and lens and allows you to concentrate more fully on the composition of your photographs. **The following features are available only when you are using an xi-Series Autozoom lens.**

Auto Stand-by Zoom (ASZ)

When Eye-Start first activates the camera, the lens immediately sets a focal length. This position is determined by the subject's distance from the camera and should provide a good starting-point in your composition. The focal length can also be quickly adjusted from this point with power zoom.

- If you move the AZ/MZ switch to MZ, -- will appear in the aperture display of the viewfinder and body data panels when Eye-Start activates the camera.

—NEXT PAGE—

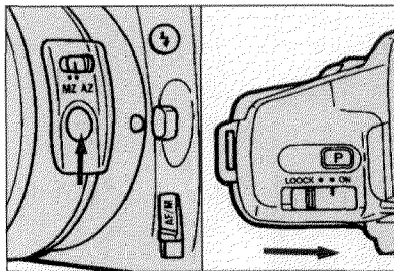
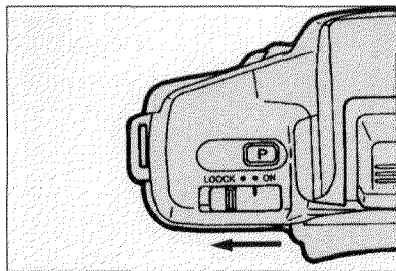

- ASZ's operation is a one-shot function; it will not set a new focal length every time you point the camera at a new subject unless you first take the camera away from your eye. If you use power zoom to change ASZ's setting, ASZ will not function again until you remove the camera from your eye and wait 30 sec.

To turn off ASZ:

1. Set the main switch to LOCK.
 2. Press and hold the lens-function button on the lens barrel while you move the main switch to ON.
- To turn ASZ on again, repeat the above steps.

Image-Size Lock



When you press and hold the lens-function button on an xi-Series lens, Image-size lock will automatically adjust the lens' focal length to maintain the size of the main subject's image in the viewfinder.

Image-size lock is limited by the focal length range of the lens you are using. If either end of the lens focal length range is reached while image-size lock is operating, the lens will stop zooming, but **IMAGE LOCK** will continue to be displayed in the viewfinder. If your subject comes back into range, Image-size lock will resume operation. To turn off Image-size lock, release the lens-function button.

—NEXT PAGE—

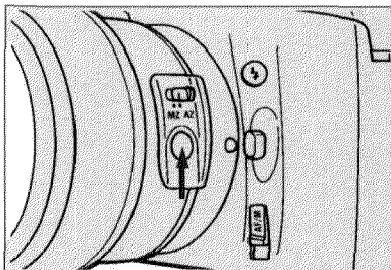

- Image-Size Lock may not be able to accurately track high-speed subjects. If your subject is moving too fast, the image size may not remain constant but **IMAGE LOCK** will continue to be displayed in the viewfinder screen.

- If you want to use continuous film advance, use low-speed mode.

In the following situations, **IMAGE LOCK** will flash in the viewfinder screen when you press the lens function button and Image-size Lock will not function:

- If your subject is too small and/or too far away for the camera to lock on to it.
- If the camera cannot focus on your subject (see Special Focusing Situations on p.43.)
- If the lens is initially set to a focal length shorter than 50mm.

Wide-View Mode

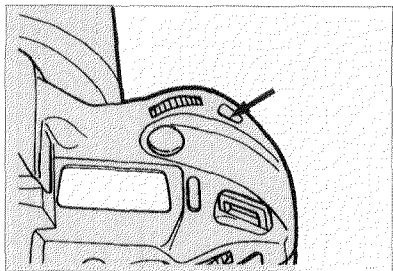

This feature enables you to see the area immediately outside of the film frame up until the moment that you press the shutter-release button.

1. Press the wide-view-mode button.

The camera will automatically set a shorter focal length to give you a wider field of view.

Both **WIDE** and the film-frame indicators will appear in the viewfinder.

— NEXT PAGE —

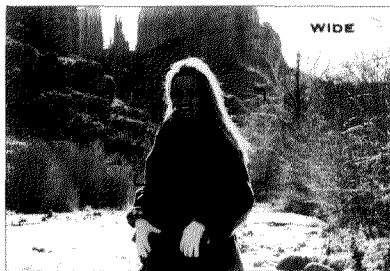
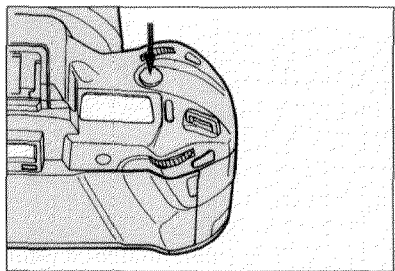

2. Compose your picture inside the film-frame indicators.
3. Press the shutter-release button partway down. The lens will zoom to fill the viewfinder with the part of the image that appears inside the film-frame indicators.
4. Press the shutter-release button down completely to take the picture.

—NEXT PAGE—

- The focal length range of any lens will be reduced slightly when you use wide-view mode. Although the lens will zoom to its shortest focal length while wide-view is activated, the view inside the film-frame marks will never be wider than 1.5 times this shortest setting, and the lens will only zoom to 2/3 its longest focal length.

For example, with a 28–105mm lens and the camera in wide-view mode, when the lens is set at 28mm, the view inside the film-frame indicators will be the same as a setting of 42mm. When you press the shutter-release button partway down, the lens will then zoom to 42mm. If you zoom the lens in the telephoto direction while still in wide-view mode, the lens will stop at 70mm, but the image inside the film-frame indicators will show the view at 105mm. The lens will then zoom to 105mm when you press the shutter-release button partway down.

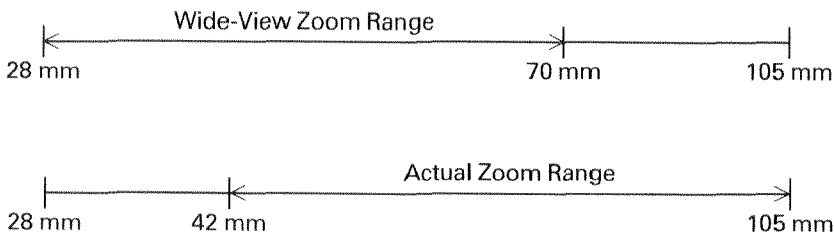

—NEXT PAGE—

● If you press the wide-view mode button with the lens set anywhere between the shortest focal length and 1.5 times the shortest focal length, the camera still enter wide-view mode. However, the image inside the film-frame marks will not be the same as that of your original focal length. Also, when you press the shutter-release button partway down, the lens will zoom forward to 1.5 times the shortest focal length, not to the position from which you started.

For example, if you set a 28–105mm lens at 35mm and press the wide-view-mode button, the view inside the film-frame indicators will be that of a 42mm setting, not 35mm. When you then press the shutter release button partway down, the lens will then zoom to 42mm.

APPENDIX

Lens Aperture and Depth of Field

Depth of field is the area in front of and behind the point on which the lens is focused which will also appear sharp in the final image. Aperture size, focal length, and subject distance are important factors in determining this range.

Aperture size is commonly expressed as an f-number or f-stop. These are the values that are displayed in the viewfinder and body data panels and which appear as part of the lens designation. An f-number is inversely related to the actual size of the aperture. For this reason, f/8 is larger than f/11, but smaller than f/5.6.

The whole-stops and half-stops between f/1.4 and f/32 are listed below. Depending on which way you move on the scale, a change of one stop, either from whole-stop to whole-stop or from half-stop to half-stop, will double or halve the amount of light reaching the film.

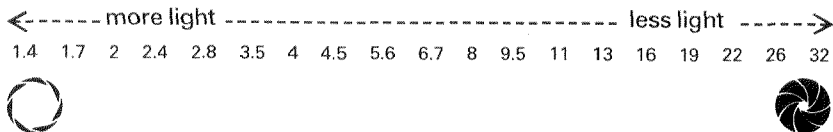



If focal length and subject distance remain constant, as the size of the lens aperture decreases, depth of field increases. Aperture-priority (A) mode, manual (M) mode, and PA enable you to vary the size of the aperture in order to directly control a picture's depth of field. Different situations usually require different amounts of depth.

For example, in a portrait situation, you may want to use a larger aperture in order to focus only on the main subject and separate the person from their background. A small aperture, on the other hand, would be preferable in such cases as landscape photography when you want as much of the scene as possible to appear in focus. Expert Program Selection will automatically set a large aperture in portrait situations so that only your main subject will appear in sharp focus, and a small aperture for landscapes and extreme close-ups to maximize depth of field.

—NEXT PAGE—



For any given f-number and subject distance, an increase in focal length will reduce the depth of field and a decrease in focal length will have the opposite effect. For example, if a 28–105mm zoom lens is set at 50mm, f/8 and the subject is 12 ft. away, changing the focal length to 90mm without altering the exposure settings or subject-to-camera distance will noticeably shorten the depth of field. Setting the lens to 28mm, however, extends the range which will appear in focus.

Depth of field also depends on subject distance. Without changing lens aperture or focal length in the above case, if you move to 6 ft. from your subject, there will be less depth of field in the final image.

The depth index provides a qualitative method for you to understand the relationship between the above three factors and background sharpness. It not only shows roughly how in-focus the background of your scene will appear, but the indicator will also change position to reflect changes in aperture, focal length, and subject distance which will also effect depth.

Shutter Speed and Moving Subjects

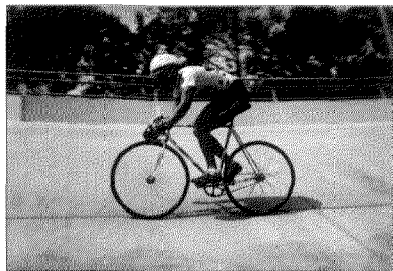

Your choice of shutter speed is an important factor in determining how moving subjects will appear in the final image. Depending on the speed of your subject, slower shutter speeds such as $1/15$ sec. will make moving subjects appear blurred and flowing in the picture, creating a greater feeling of motion. Fast shutter speeds, of course, are useful to freeze fast action.

Also, if you are using a telephoto lens, a fast shutter speed can help prevent blurring caused by camera shake. For lenses longer than $f' = 50\text{mm}$, a general rule to follow is that $1/f'$ is the slowest usable shutter speed while the camera is being hand-held. For example, if you are using a 135mm lens, try to avoid using shutter speeds slower than $1/200$ sec. (the closest shutter speed to $1/135$) without mounting the camera on a tripod.

The action index provides a simple way for you to visualize approximately how your subject will appear in the final picture. The camera's expert system compares the speed of your subject's image and compares it to the shutter speed you have selected. It then positions the indicator to illustrate roughly how much the image will be blurred.

Composition

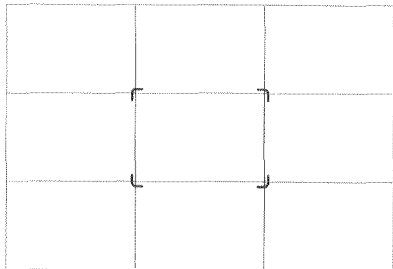

In both horizontal and vertical mode, the AF brackets should be regarded as reference area for positioning your subject within the frame. In horizontal mode, the brackets follow the “Rule of Thirds,” a common rule in photographic composition which states that the important components of a picture should be placed near to the intersections of the lines which divide the frame into thirds both horizontally and vertically. The horizontal-mode AF brackets lie on those intersection points.



If, for example, you are taking a portrait, try placing your subject near one of the four points, with the person facing towards the center of the picture. This will help to include some of the background in the picture and make a more interesting composition.

In the case of a landscape, experiment with different compositions—place the important elements off-center and let the horizon run through one of the one-third dividing lines to give your picture more of a dynamic quality. When the camera is held vertically, the brackets change to reflect changes in the AF area and in composition which you may want to consider before you take the picture. All of these are, of course, merely suggestions and starting points. Experiment to find the qualities which will make up your own unique style.

You will notice that there are no AF sensors located directly beneath any of the brackets. For this reason, you may have to use focus lock in order to ensure that your main subject is in focus.

ACCESSORY INFORMATION

If you already have own MINOLTA accessories, check their compatibility before using them with your 7xi.

1. LENS

All Minolta AF lenses can be used with the 7xi. Autozoom function (ASZ, APZ, Image-size lock and Wide-view mode) are possible only if the 7xi is used with an Xi-Series lens.

Manual focusing lenses (MD or MC) cannot be attached the 7xi.

Shadowing on the bottom of picture may occur in your pictures when the 7xi's built-in flash is used together with the lens listed below. Before using any of these lenses, check with the nearest Minolta Service facility for the conditions of their use:

AF 28-85mm f/3.5-4.5

AF 200mm f/2.8 APO TELE

AF 28-135mm f/4-4.5

AF 200mm f/2.8 APO TELE (N)

The following lenses cannot be used under any conditions with the 7xi's built-in flash:

AF 300mm f/2.8 APO TELE

AF 300mm f/2.8 APO TELE (N)

AF 600mm f/4 APO TELE

AF 600mm f/4 APO TELE (N)

Keep in mind, too, that the built-in flash provided coverage for lenses with focal length no wider than 28mm. The above information applies only to use with the 7xi's flash.

2. FLASH

Minolta i- and Xi-Series flash units can be used.

Flash Shoe Adapter FS-1100 must be used to attach an AF-series flash to the 7xi. When used with the 7xi, these units fire whenever a picture is taken, regardless of the exposure mode selected.

In all exposure modes TTL flash control will operate.

3. CARDS (Refer to table)

O: can be used. --- : cannot be used. 1 to 7: can be used with the conditions listed below.

1. The display on the data panel is the same as Automatic Depth Control's.

2. Settings must be made with front control dial. When you use the Multiple Exposure Card in the 7xi with either the built-in flash or an accessory flash and you set high or low continuous drive before you insert the card, the drive mode indicator or will remain in the body data panel when you activate the

card. However, only single-frame advance will operate when you press the shutter-release button.

3. Settings must be made with front control dial. Because 7xi has no manual aperture button, it cannot vary the aperture in M mode.

4. Settings must be made with the front control dial. Exposure settings for the next frame appear when you take the 7xi away from your eye.

5. The starting point of the exposure series cannot be changed from the settings chosen by Expert Program Selection.

6. When you insert this card the into 7xi, spot metering is automatically activated. Exposure readings are stored by pressings the AE lock button and the number of readings is displayed in the viewfinder data panel.

7. When you insert this card into 7xi, spot metering is automatically activated. Exposure readings are stored by pressing the AE lock button.

	CARD NAME	7xi	8000i	7000i	5000i
SPECIAL APPLICATION CARDS	Travel	○	1	1	1
	Child	○	---	---	---
	Automatic depth control	○	○	○	○
	Sports action	○	○	○	○
	Portrait	○	○	○	○
	Closeup	○	○	○	○
FEATURE CARDS	Panning	○	---	---	---
	Intervalometer	○	---	---	---
	Background priority	○	---	---	---
	Multipule exposure	2	○	---	---
	Exposure bracketing	3	○	○	---
	Flash bracketing	4	○	○	---
	Data memory	2	○	○	---
	Fantasy efect	○	○	○	---
	Automatic program shift	5	○	○	---
	Multi spot memory	6	○	○	---
	Highlight/shadow control	7	○	○	---
	A/S mode	---	---	---	○
Customized function	Customized function card xi	○	---	---	---
	Customized function card	---	○	○	---

CARE AND STORAGE

- Always keep your camera in its case with the lens capped when not in use, or with a body cap on when a lens is not attached.
- No part of the camera should be forced at any time.
- 72-exposure cartridge and polaroid instant 35mm films cannot be used.
- Never subject your camera to shock, high heat, humidity, water, or harmful chemicals. Be particularly careful not to leave it in the glove compartment or other places in motor vehicles where it may be subjected to high temperatures.
- Never lubricate any part of the camera body or lens.
- Never touch the shutter curtains, mirror, or the interior of the body or clean them with compressed air. Doing so may impair their alignment and movement.
- External camera surfaces and lens barrel—but not glass surfaces— can be cleaned by wiping with a dry or silicone-treated cloth. Never use organic solvents to clean the camera.
- Never touch the lens or eyepiece surfaces with your fingers. Whisk away loose matter with a blower brush. To remove stubborn spots, use a sheet of photographic lens tissue. If necessary, tissue may be moistened with one drop of lens-cleaning fluid; Never place fluid directly on glass surfaces.
- We recommend that you have your camera cleaned once a year at an authorized Minolta service facility.
- If you plan to store your camera for an extended period of time, rewind and remove the film, then remove the battery. Place the camera in a cool, dry place away from dust or chemicals, preferably in an airtight container with a drying agent such as silica gel. Also, it is recommended that you periodically release the camera's shutter to maintain proper working condition.

- This camera is not waterproof or dustproof or sand-proof. If you use this camera near water or at the beach, water-, dust-, or sand-damage may occur. Protect it from moisture or splashes, especially saltwater spray, and be extremely careful to keep sand from both the interior and exterior of the camera and its accessories. If it comes in contact with water, wipe it with a clean, dry cloth and bring it to an authorized Minolta Service facility. If it comes in contact with sand or if sand enters the camera, gently blow away loose particles--**wiping may scratch the camera**--and bring it to an authorized Minolta Service facility.
- This camera is not water proof. If it comes in contact with water, wipe it with a dry cloth and bring it to an authorized Minolta Service facility.
- If the camera is subjected to a sudden change in temperature, as when transferring it from a cold environment into a heated building, condensation may form inside. To prevent condensation, place the camera in a sealed plastic bag before transferring it from a cold place to a warm environment, and wait for it to come to room temperature before taking it out of the bag.
- After prolonged storage, and especially before taking pictures at an important event, carefully check the operation of the camera and lens.
- The operating range for camera's data panel is from -20 to 50°C (-4 to 122°F). At temperatures outside this range, response time and contrast will change, making the display difficult to read. At very high temperatures, a display may temporarily darken. If this occurs, the display should return when the camera is restored to operating range conditions.
- This camera contains no user-serviceable parts. Do not attempt to disassemble or repair the camera yourself.
- This camera's circuitry may switch off, even when a battery with sufficient power is installed. To resume operation, remove the battery and install it again.

TROUBLESHOOTING

PROBLEM	CAUSE	SOLUTION
No display in the data panel when the camera is switched on.	Battery exhausted.	Install a fresh battery.
	Battery not installed correctly.	Remove the battery and install it correctly.
-- appears in the data panel's aperture display.	Lens not attached correctly.	Attach the lens so that it locks in place with a click.
	Contacts on camera and/or lens are dirty.	Clean contacts with a dry, clean cloth.
	AZ/MZ switch set to MZ.	Move the AZ/MZ switch AZ.
HELP displayed in the body data panel.	Winding motor problem.	Remove the battery, then reinstall it.
Autofocus does not work or the lens does not focus when the shutter-release button is pressed.	Camera set to manual focus.	Set the camera to autofocus mode.
	AZ/MZ switch set to MZ.	Turn the AZ/MZ switch AZ.
	Lens is not attached correctly.	Attach the lens so that it locks in place with a click.
	Subject difficult to autofocus.	Focus manually.
Camera cannot be shifted out of P mode.	Creative Expansion Card in use.	Use the card key to switch the card off.
Card system does not function.	Card not installed correctly.	Remove and reinsert the card correctly.
Eye-Start does not work.	Grip Sensor is not activated.	Touch the Grip Sensor

TECHNICAL DESCRIPTION

Type: 35mm SLR with expert control of autofocus (AF), autoexposure (AE), and autozoom (AZ); auto film transport; built-in motor drive; and built-in flash

Lens Mount: Minolta A-type bayonet mount; accepts all Minolta AF lenses

Eye-Start System: AF, AE and AZ automatically activated by combination of eyepiece sensors and grip sensors

AF system: Minolta's through-the-lens (TTL) phase-detection system with four CCD sensors: activated by Eye-Start; Multi-dimensional Predictive Focus Control; built-in AF illuminator automatically activated in low-light/low-contrast conditions; AF sensitivity range: EV -1 to 19 (at ISO 100 in ambient light) AF illuminator range: 0.7 to 9m (Based on Minolta's standard test methods)

Manual Focusing: *Visually on acute-matte view-finder screen*

Metering: TTL-type; 14-segment honeycomb-pattern silicon photocell (SPC); automatically activated by Eye-Start; second SPC for TTL flash metering of built-in flash or other dedicated flash unit; metering modes: honeycomb-pattern or spot metering; range: honeycomb-pattern EV 0-20, spot metering EV 3-20 (ISO 100, 50mm f/1.4 lens)

Exposure Modes: Programmed AE: Automatic control of aperture and shutter speed depending on lens specifications and scene characteristics; PA, PS: Creative Program Control

Aperture-priority AE: Any available aperture in 1/2-stop increments; shutter speed set steplessly from 1/8000 to 30 sec. automatically by autoexposure program

Shutter-priority AE: Any shutter speed from 1/8000 to 30 sec. selectable in 1/2-stop increments; aperture set automatically by autoexposure program

Manual: Any shutter speed/aperture combination selectable in 1/2-stop increments; correct and over-/under-exposure indicated in viewfinder: BULB setting also selectable

Built-in flash: Activated when shutter release is pressed partway down; guide number 12 (in meters at ISO 100); coverage for 28mm field of view; approx. 2 sec. recycle time; Modes: autoflash, autoflash with pre-flash, flash-cancel, remote off-camera

—NEXT PAGE—

TTL Flash Metering: Operates in all flash modes with dedicated flash unit; x-sync shutter speed automatically set when flash-on signal appears in viewfinder; in P, A, or S mode, pressing AE-lock button sets slower shutter speed (down to 30 sec.) to balance flash with ambient lighting

Programmed AE: Aperture and shutter speed set automatically; built-in or accessory flash fires automatically when necessary

Shutter-priority AE: Aperture and shutter speed set automatically; flash will fire when popped-up (built-in flash) or activated (accessory flash)

Aperture-priority AE: Any available aperture usable; flash will fire when popped-up (built-in flash) or activated (accessory flash)

Manual: Any available shutter speed or aperture usable; flash will fire when popped-up (built-in flash) or activated (accessory flash)

Exposure Compensation: +/- 4 stops in 1/2-stop increments

Shutter: Electronically-controlled, vertical-traverse, focal-plane type

Automatic speeds: In program and aperture-priority AE modes, stepless 1/8000 to 30 sec. with nearest half-stop displayed

Manual speeds: In shutter priority AE and manual modes, 1/8000 to 30 sec. in 1/2-stop increments plus BULB in manual mode

Expert Autozoom (with xi-Series Autozoom lens):

ASZ: Programmed selection of focal length based on subject distance; automatically activated Eye-Start

APZ: Programmed continuous setting of focal length based on changing subject position (only with specified CE cards)

Image-size lock: Continuous setting of focal length to maintain image size

Wide-View Mode: Focal length re-set to allow viewing of 150% of actual image area until shutter release is pressed partway down.

Film-speed Setting: Automatic Setting for DX-coded films; for films without DX-coding, previous ISO value set; manual setting also possible

Automatic range: ISO 25-5000 in 1/3-stop increments

Manual range: ISO 6-6400 in 1/3-stop increments

Film transport: Automatic with built-in motor drive; auto threading, auto advance to first frame; single-frame advance or 2-speed continuous advance at up to 4 frames per second; automatic rewind or manual start of rewind; frame counter in body data panel

Controls: Buttons for self-timer/drive mode, manual start of film rewind, flash mode, film speed, viewfinder mode, card on/off, AE lock, dial function selection, program re-set, card adjust, main switch

Viewfinder: Eye-level fixed pentaprism showing 92% of vertical and 94% of horizontal field of view; magnification 0.75 with 50mm lens at infinity; transparent LCD screen and Acute-Matte screen

Viewfinder displays: Inside screen: Image-control index, control dial indicators, AF area indicators, spot metering area, panorama indicator, wide-view mode indicator, manual focus indicator, image-size lock indicator

Outside screen: Flash-on indicator, flash-mode/flash-ready indicator, camera-shake warning, shutter-speed/film-speed indicator, exposure signals/exposure-adjustment indicator, aperture/exposure-compensation display, AEL indicator

Body data panel displays: LCD display with indicators for exposure mode, wide/local focus area, flash mode, self-timer, drive mode, frame counter, film-loaded, card activated, metering mode, exposure compensation, battery condition, ISO, shutter speed/film speed, aperture/exposure compensation

Power: 6-volt 2CR5 lithium battery; automatic battery check when camera is turned on; battery condition indicated by four-stage indicator in body data panel; shutter locks when battery is exhausted

Self-timer: Electronic with 10-sec. delay; cancelable; operation indicated by blinking LCD

Other: Eyepiece cap, film window, remote-control socket, carrying strap, eyepiece cup

Dimensions: 163mm (6-7/16in.) x 100mm (3-15/16in.) x 67mm (2-5/8in.)

Weight: 650g (1lb. 6-15/16 oz.) without lens and battery

Specifications and accessories are based on the latest information available at the time of printing and are subject to change without notice.

When you want to

Set A mode

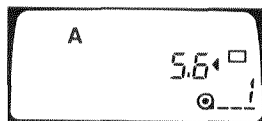
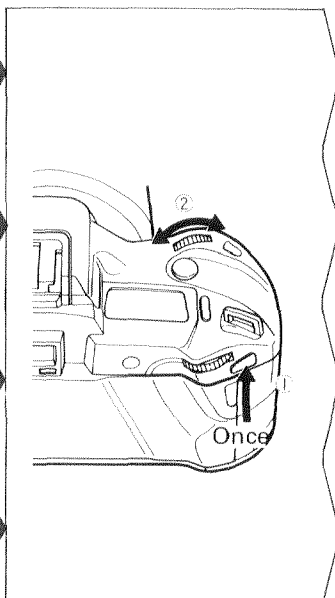

Set P mode

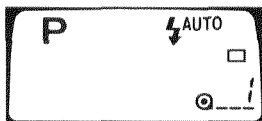

Set S mode

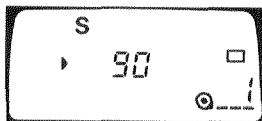

Set M mode

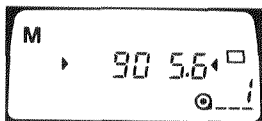



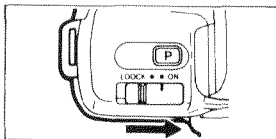
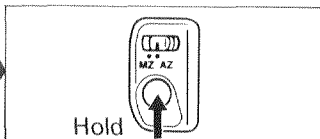

Cancel ASZ

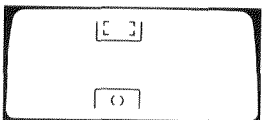
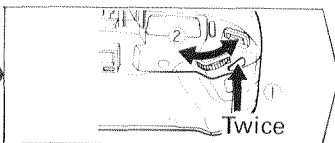

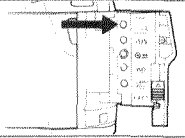
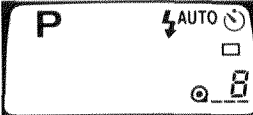
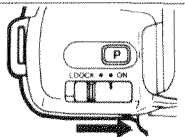
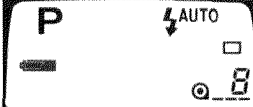
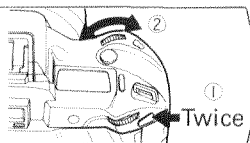
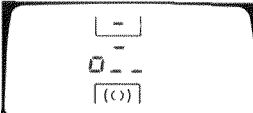
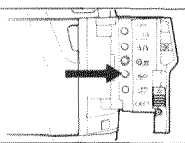
Set spot metering

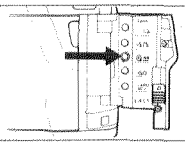
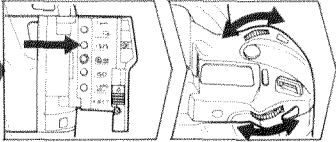

Self-timer		
Battery check		
Local AF area		
Check film speed		
Manual rewind		
Cancel flash (P mode)		

**Cancel
flash (A, S,
M mode)**

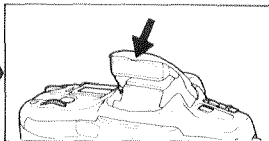

**Manual
fill-flash
(P mode)**

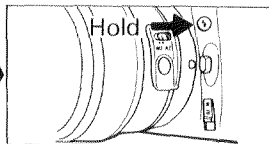

**Manual
fill-flash
(A, S and
M mode)**

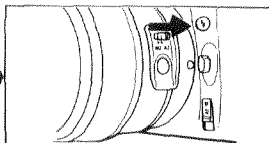

**Remove
film**

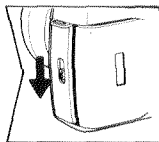

**Focus lock
(Xi lenses)**

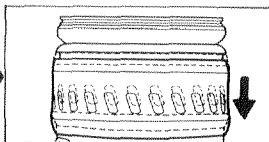

**Focus lock
(specified
AF lenses)**

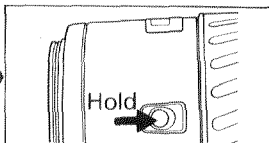

**Focus
and
AE lock**

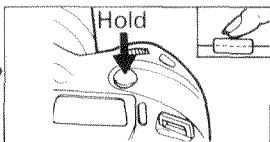

**Set
pre-flash**

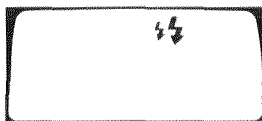
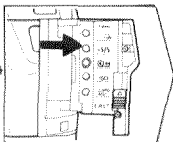

**Set
drive
mode**

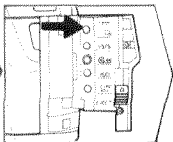

or

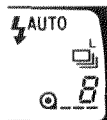

**Remove
lens**

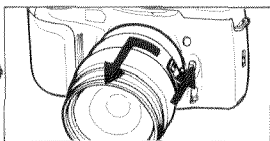

**Set
exposure
compensation**

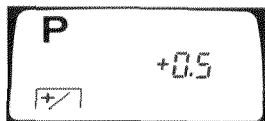
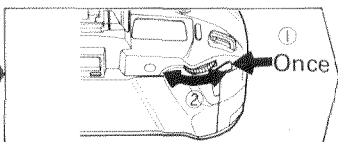

AE lock

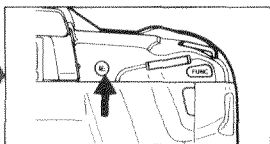

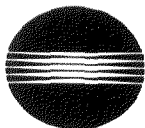

MINOLTA

Minolta Camera Co., Ltd.

Minolta GmbH

Minolta France S.A.

Minolta (UK) Limited

Minolta Austria Ges. m.b.H.

Minolta Camera Benelux B.V.

Belgium Branch

Minolta (Schweiz) AG

Minolta Svenska AB

Finland Branch

Minolta Portugal Limitada

Minolta Corporation

Head Office

Los Angeles Branch

Minolta Canada Inc.

Head Office

Vancouver Branch

Minolta Hong Kong Limited

Minolta Singapore (Pte) Ltd.

3-13, 2-Chome, Azuchi-Machi, Chuo-Ku, Osaka 541, Japan

Kurt-Fischer-Strasse 50, D-22923 Ahrensburg, Germany

365, Route de Saint-Germain, 78420 Carrieres-Sur-Seine, France

1-3 Tanners Drive, Blakelands North, Milton Keynes, MK14 5BU, England

Amalienstrasse 59-61, 1131 Wien, Austria

Zonnebaan 39, P.O. Box 1364 3600 Maarssebroek,
The Netherlands

Kontichsesteenweg 38, B-2630 Aartselaar, Belgium

Riedstrasse 6 8953 Dietikon, Switzerland

Brännkyrkagatan 64, Box 17074, S-10462 Stockholm 17, Sweden

Niittykatu 6 PL 37 SF-02201 Espoo, Finland

Av. do Brasil 33 a, 1700 Lisbon, Portugal

101 Williams Drive, Ramsey, New Jersey 07446, U.S.A.

11150 Hope Street Cypress, CA 90630, U.S.A.

369 Britannia Road East, Mississauga, Ontario L4Z 2H5, Canada

106-3850 Jacombs Road, Richmond, B.C. V6V 1Y6, Canada

Room 208, 2/F, Eastern Center, 1065 King's Road, Quarry Bay, Hong Kong

10, Teban Gardens Crescent, Singapore 2260

© 1991 Minolta Camera Co., Ltd. under the Berne
Convention and Universal Copyright Convention