

MINOLTA

**MAXXUM<sup>®</sup>**  
**DYNAX<sup>™</sup>**

***5xi***

**E INSTRUCTION MANUAL**

## INTRODUCTION

Congratulations on owning a highly innovative Minolta autofocus SLR.

This instruction manual is designed to help you get the most enjoyment and use out of your camera and is in sections for easy reading and quick reference. Also, it includes a glossary in the back that provides simplified definitions of common photographic terms. First, look over the parts diagrams and familiarize yourself with the controls, their names, and their locations. This will be helpful later when they are introduced in the manual and you learn about their functions. Next, read Preparations, attach the strap, insert the battery, etc.

After you are familiar with the controls and used to holding the camera, read Simple Operation, then you should be ready to use the 5xi in the simplest way possible. As you use the camera, you will begin to realize the power of features such as:

- Expert Flash System
- Predictive Focus Control
- Expert Program Selection with fuzzy logic control
- Creative Program Control

When you are ready for advanced control of the 5xi, Operations in Detail and the Appendix will help you to increase your knowledge to master this unique camera, and expand your control over the medium of photography. After reading this manual, if you need a reminder of how to perform a general camera operation, please refer to the Quick Reference Guide located in the back.

Throughout this instruction manual, certain parts and features will have two names, the first for Dynax and the second for Maxxum. Maxxum is the name of Minolta SLR cameras in North America and Dynax in all other countries except Japan.

## **IMPORTANT INFORMATION**

The Minolta 5xi was designed to work specifically with lenses, flash units, and other accessories manufactured and distributed by Minolta. We therefore caution users of this camera that the attachment and/or use of incompatible products with the 5xi may result in unsatisfactory performance or damage to the camera or its accessories. To obtain *optimum performance throughout the life of your 5xi*, we recommend that you use only those lenses, flashes and other accessories distributed by Minolta specifically for use with this camera.

## **STATEMENT OF FCC COMPLIANCE**

This device complies with Part 15 of the FCC Rules. Operation is subject to the following conditions: (1) This device may not cause harmful interference, and (2) this device must accept any interference received, including interference that may cause undesired operation. Changes or modifications not approved by the party responsible for compliance could void the user's authority to operate the equipment. This equipment has been tested and found to comply with the limits for a Class B digital device, pursuant to Part 15 of the FCC Rules. These limits are designed to provide *reasonable protection against harmful interference in a residential installation*. This equipment generates, uses and can radiate radio frequency energy and, if not installed and used in accordance with the instructions, may cause harmful interference to radio communications. However, there is no guarantee that interference will not occur in a particular installation. If this equipment does cause harmful interference to radio or television reception, which can be determined by turning the equipment off and on, the user is encouraged to try to correct the interference by one or more of the following measures:

Reorient or relocate the receiving antenna.

Increase the separation between the equipment and receiver.

Connect the equipment into an outlet on a circuit different from that to which the receiver is connected. Consult the dealer or an experienced radio/TV technician for help.

## **STATEMENT OF DOC COMPLIANCE**

This digital apparatus does not exceed the Class B limits for radio noise emissions from digital apparatus as set out in the Radio Interference Regulations of the Canadian Department of Communications.

# TABLE OF CONTENTS

## NAMES OF PARTS AND DISPLAYS

Body .....	6
Body Data Panel .....	9
Viewfinder Screen and Viewfinder Data Panel .....	10

## PREPARATIONS

<b>Preliminary</b> .....	12
Neckstrap .....	12
Eyepiece and accessory shoe cap .....	12
<b>Battery</b> .....	13
Inserting .....	13
Battery-condition indicators .....	14
Battery performance .....	15
Cold-weather operation .....	15

## SIMPLE OPERATION

<b>Main Switch/Eye-Start</b> .....	22
<b>Holding the Camera</b> .....	23
Camera-shake warning .....	23
<b>Taking Pictures</b> .....	24
Focus signals .....	25
<b>Focus Lock</b> .....	26



<b>Lens</b> .....	16
Attaching .....	16
Removing .....	17
Care of glass surfaces .....	17
<b>Film</b> .....	18
Loading film .....	18
Automatic film speed setting .....	20
Automatic rewind .....	20
Manual start of rewind .....	20

<b>Programmed Autoexposure (P)</b> .....	27
<b>Flash Basics</b> .....	28
Auto-switchover flash (P mode) .....	28
Viewfinder signals .....	29
Pre-flash .....	30

## OPERATIONS IN DETAIL

<b>Focusing Details</b> .....	32
Autofocus illuminator .....	32
Special focusing situations .....	33
Manual focus .....	34
<b>Exposure Details</b> .....	35
PA/Ps: Creative program control .....	35
Changing exposure mode .....	36
A:Aperture priority .....	37
S:Shutter priority .....	38
M:Manual exposure .....	39
Bulb: Long exposures .....	40
Spot metering .....	42
Exposure compensation .....	44

## APPENDIX

<b>Lens Aperture and Depth of Field</b> .....	58
<b>Shutter Speed and Moving Subjects</b> .....	60
<b>Accessory Information</b> .....	61
Creative expansion cards .....	61
Lens .....	63
Flash .....	63

<b>Self-timer</b> .....	45
<b>Flash Details</b> .....	46
Manual fill-flash (P mode) .....	46
Flash cancel (P mode) .....	46
A, S, and M mode flash .....	47
Flash range .....	47
Slow-shutter sync. flash .....	48
Remote/Wireless off-camera flash control .....	49
Remote/Wireless slow-shutter sync. ....	52
Ratio control .....	52
<b>Film Drive</b> .....	53
<b>Autozoom System</b> .....	54
Auto stand-by zoom .....	54
Image-size lock .....	55
<hr/>	
<b>Care and Storage</b> .....	64
<b>Troubleshooting</b> .....	66
<b>Technical Details</b> .....	69
<b>Glossary</b> .....	72
<b>Quick Reference Guide</b> .....	74

## NAMES OF PARTS AND DISPLAYS

### Body

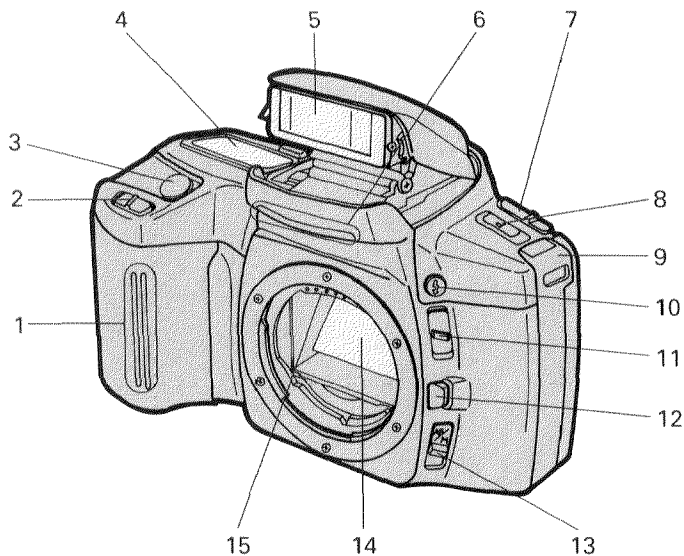

\* Do not touch

- |                                |                              |
|--------------------------------|------------------------------|
| 1. Grip sensor                 | 9. Strap eyelet              |
| 2. Shutter-setting control     | 10. Flash-control button     |
| 3. Shutter-release button      | 11. Aperture-setting control |
| 4. Body data panel             | 12. Lens release             |
| 5. Flash                       | 13. Focus-mode switch        |
| 6. Self-timer-indicator window | 14. Mirror*                  |
| 7. Main switch                 | 15. Lens contacts*           |
| 8. Program-reset button        |                              |

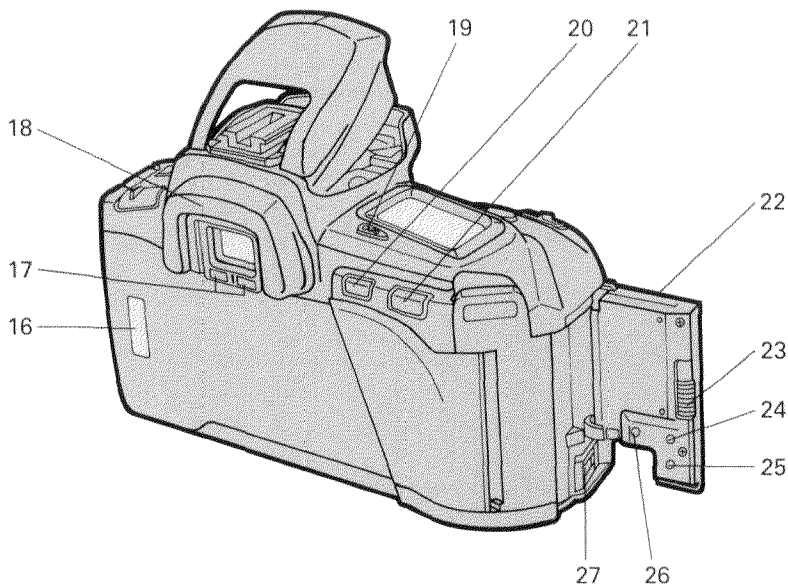

- 16. Film window
- 17. Eyepiece sensor\*
- 18. Eyepiece cup
- 19. Card-on/off button
- 20. Spot-metering button
- 21. Function button

- 22. Card door
- 23. Card-eject slide
- 24. Self-timer/Drive-mode button
- 25. Pre-flash button
- 26. Card-adjust button
- 27. Remote-control terminal

## (Name of parts and displays)

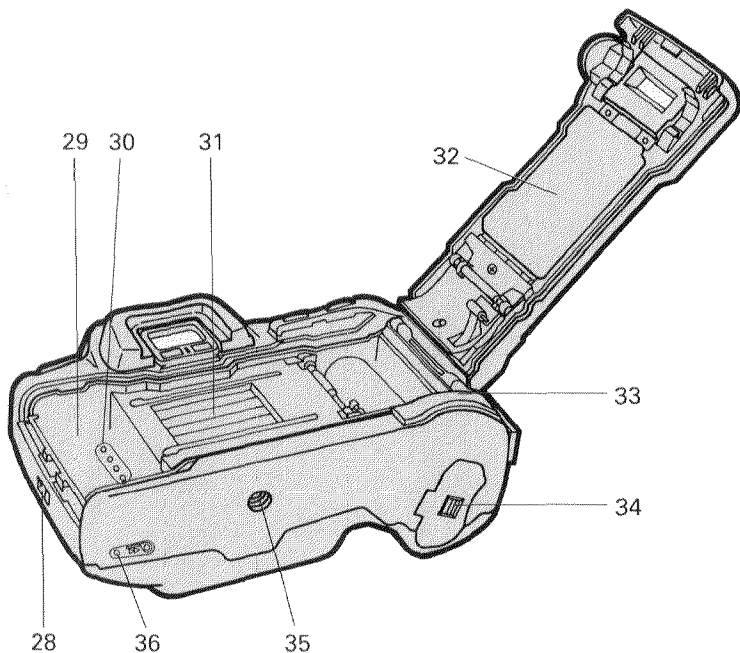

28. Back-cover release

29. Film chamber

30. DX contacts\*

31. Shutter\*

32. Pressure plate\*

33. Film-leader index

34. Battery-cover release

35. Tripod socket

36. Rewind button

## Body Data Panel

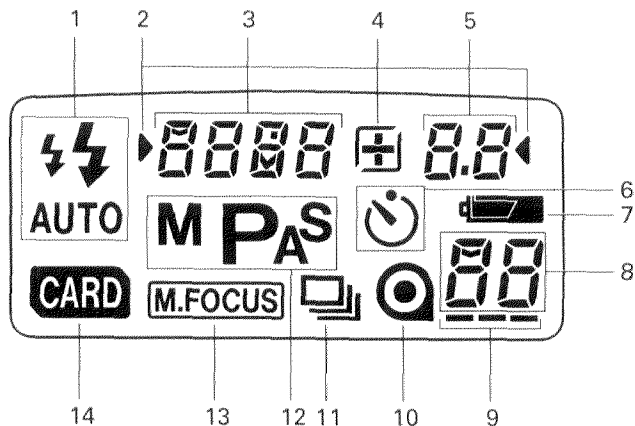

- |  |                                       |
|--|---------------------------------------|
| 1. Flash-mode indicator                                  | 8. Frame counter/Card-setting display |
| 2. Selectable-setting pointers                           | 9. Film-transport signals             |
| 3. Shutter-speed/Card-name display                       | 10. Film-cartridge mark               |
| 4. Exposure-adjustment indicator                         | 11. Drive-mode indicator              |
| 5. Aperture/Exposure-adjustment/<br>Card-setting display | 12. Exposure-mode indicator           |
| 6. Self-timer indicator                                  | 13. Manual-focus indicator            |
| 7. Battery-condition indicator                           | 14. Card indicator                    |

## (Name of parts and displays)

### Viewfinder Screen and Viewfinder Data Panel

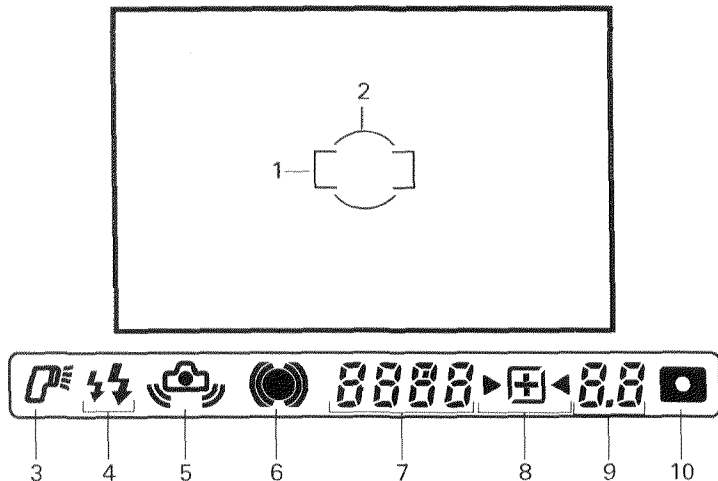

1. Focus frame
2. Spot-metering frame
3. Flash-on indicator
4. Flash-ready indicator
5. Camera-shake warning
6. Focus signal
7. Shutter-speed display
8. Exposure signals/Exposure-adjustment indicator
9. Aperture/Exposure-adjustment display
10. Spot-metering/Slow-shutter-sync. indicator



# PREPARATIONS

This section includes those things which you should do and understand before you use your camera. Read it thoroughly before you go on to **SIMPLE OPERATION** or **OPERATIONS IN DETAIL**.

## PRELIMINARY

### Neckstrap

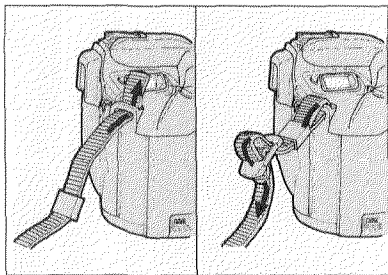

A neckstrap is supplied with your camera. Attach it as shown.

### Eyepiece and accessory shoe cap

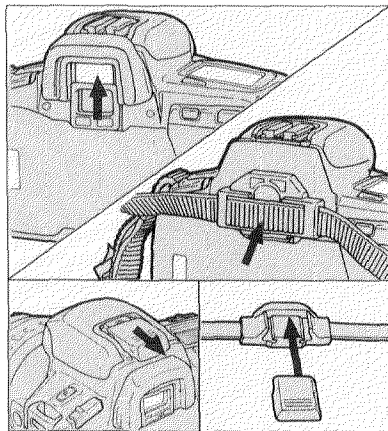

An eyepiece cap is included on the strap. During situations such as self-timer photographs or bulb exposures in which you are not looking through the viewfinder when the shutter releases, remove the eyepiece cup and fit the cap over the eyepiece. This will prevent stray light from entering the camera and affecting the exposure.

The camera also comes with an accessory shoe cap which protects the accessory-shoe contacts. When you are using a flash or other accessory, slide the accessory shoe cap into the eyepiece cap for safekeeping.

# BATTERY

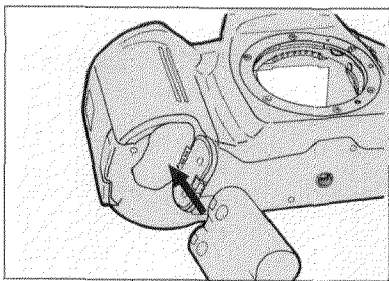
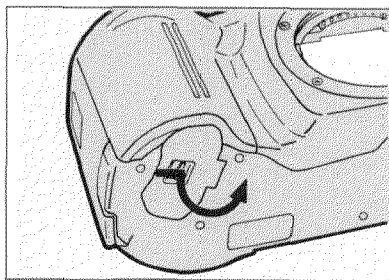

This camera uses a 6-volt 2CR5 lithium battery to supply power to all of its operations. If you are also using an xi-Series lens, the camera battery also supplies power to the zoom motor built into the lens.

## Inserting

1. Slide the main switch to **LOCK** and slide the battery-cover release in the direction indicated to open the battery cover.
2. Insert the battery according to the marks on the inside of the chamber cover.
3. Snap the cover closed.





## CAUTION

- Read and follow all warnings and instructions supplied by the battery manufacturer.
- Do not attempt to disassemble, recharge, or short-circuit the battery. Do not subject it to high temperatures or fire. The battery may explode and cause severe burns.
- Keep batteries away from small children.

## (Battery)

### Battery-condition indicators

When you slide the main switch from **LOCK** to **ON**, one of the following indicators will appear in the data panel.

Display	Indication	Meaning
	1. Full-battery symbol appears for 4 sec. after you turn camera on.	Power is sufficient.
	2. Low-battery symbol appears for 4 sec. after you turn camera on.	Power is sufficient, but getting low. Keep a fresh battery handy.
	3. Low-battery symbol blinks while it appears with other operating indicators at any time during use.	Camera can be operated, but power is extremely low. The battery will need to be changed soon.
	4. Low-battery symbol and "bAtt" appears, or no display appears at all, and shutter locks.	Power is insufficient for operation. Replace battery or check that the battery is inserted correctly.

- Indicator 4 will appear even while the main switch is set to **LOCK**.
- If no display appears when the main switch is **ON**, double-check that the battery is inserted correctly before inserting a fresh one.

## **Battery performance**

The 6-volt 2CR5 lithium battery should provide sufficient power for shooting up to 55 rolls of 24-exposure film without flash, 20 rolls of 24-exposure with flash used 50% of the time. These figures are based on Minolta's standard test method using a fresh battery at 20°C (68°F). Actual performance will depend on how you use the camera. If you install a new battery that has been in prolonged storage, the camera's performance may vary.

## **Cold-weather operation**

Lithium batteries perform well in cold weather. However, if you plan to shoot many rolls of film outdoors at temperatures near or below 0°C (32°F), we recommend that you carry the camera inside your coat to keep it warm while you are not shooting. You may also want to carry a spare battery in your pocket so that you can change the camera battery if necessary. Do not discard a cold battery. After it warms up, it will regain some of its charge.

# LENS

## Attaching

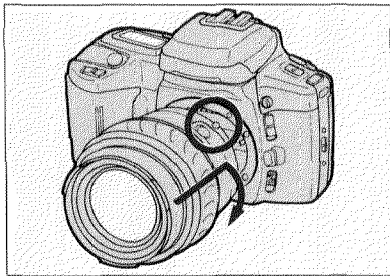
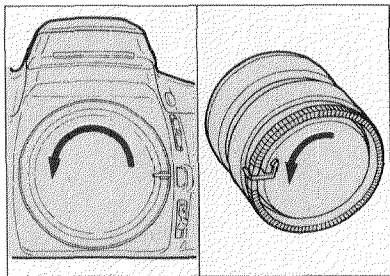

1. Remove the body cap and rear lens cap.
2. Align the red bead on the lens barrel with the red dot on the camera's lens mount. Fit the lens into the mount and turn the lens clockwise until it locks in place with a click.

### Be careful...

- Do not force the lens if it does not turn smoothly.
- Never touch anything inside the camera, especially the lens contacts and mirror.

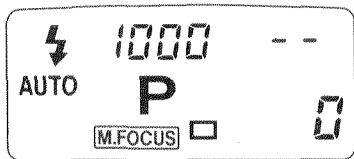

"--" will appear in the aperture display of the data panel if:

- No lens is attached to the camera
- The lens is not attached properly
- The AZ/MZ switch on an xi-Series lens is set to **MZ**

## Removing

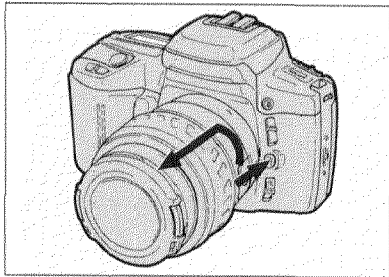

1. Press and hold the lens release while turning the lens counter-clockwise until it stops. Lift the lens out of the mount.
2. Immediately attach the rear cap to the lens and the body cap or another lens to the camera. This will protect the lens elements, lens contacts, and camera interior.

### Care of Glass Surfaces

- Never touch any lens surfaces (including the eyepiece) with your fingers. If a lens becomes dirty, first gently clean it with a lens brush. Then, if necessary, moisten a sheet of lens tissue with one drop of lens-cleaning fluid and, starting from the center of the lens, wipe the glass using a circular motion.
- Never lift the mirror or touch its surface. This may impair its alignment or scratch its face. Dust on the mirror's surface will not affect meter readings or picture quality. If it is distracting, have the camera cleaned at an authorized Minolta service facility.

## Loading film

Before you load a roll of film, always check the body data panel. If the film-cartridge mark is displayed, **do not open the back cover**. Check the film window and frame counter to verify the type of film in the camera and the number of frames remaining. (See p.20 for instructions on rewinding an unfinished roll of film.)

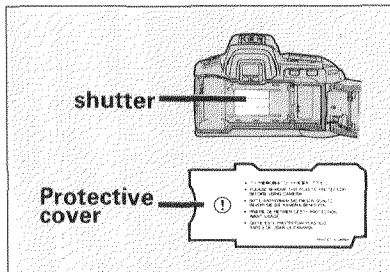

- Before you load film for the first time, carefully remove and discard the protective paper cover over the shutter.

- Always load film in subdued light or shade.

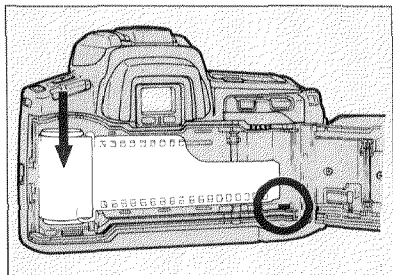
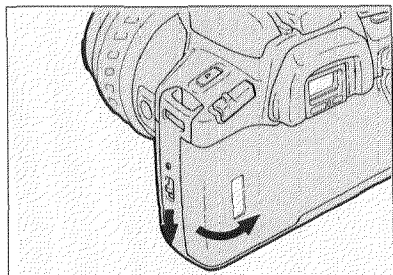

1. Open the back cover by sliding the back-cover release downward.
2. Place the film cartridge into the film chamber and extend the leader between the guide rails until the tip is just past the film-leader index.



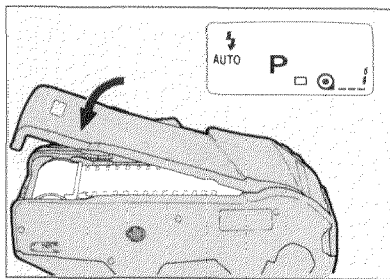

3. Close the back cover and slide the main switch to **ON**. The camera will automatically advance the film to the first frame and **1** will appear in the frame counter.

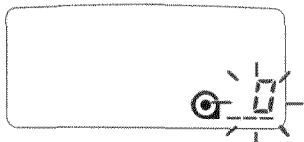

- If the film is loaded incorrectly, **0** will blink in the frame counter and the shutter will remain locked. Open the back cover and repeat steps 2 and 3.

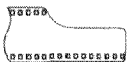

RIGHT

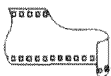

WRONG

- If the film leader is torn or crimped, it may not wind properly.

- If the film tip extends beyond the mark, gently push the excess back into the cartridge.

- If you slide the main switch to **ON** before you load film, do not touch the grip sensor during the above procedures because ASZ may activate.

**Be careful...**

**NEVER TOUCH THE SHUTTER.** Its precision design makes it extremely sensitive to pressure.

## (Film)

### Automatic film speed setting



If you use DX-coded film between ISO 25 and 5000, the camera will automatically set the correct film speed. For flash photography, Minolta recommends that you use film between ISO 25 and 1000. If you use non-DX-coded film, ISO 100 will be automatically selected by the camera.

### Automatic rewind

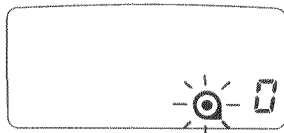

After you have exposed the last frame, the camera will automatically rewind the film. With a fresh battery, it takes about 18 sec. to rewind a 36-exposure roll, or 12 sec. for a 24-exposure roll.

When the film has been completely rewound, the motor will stop and the film-cartridge mark in the data panel will blink to indicate that it is safe to open the camera back.

### Manual start of rewind

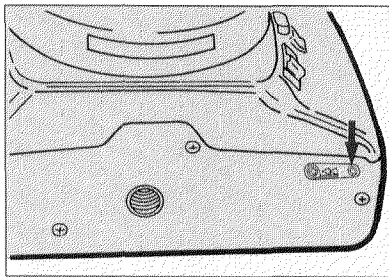

To begin rewind at any time, use a ball point pen or similar object to press the rewind button on the bottom of the camera body.

- If the motor stops before the film is completely rewound, insert a fresh battery.

# **SIMPLE OPERATION**

This brief section is intended to help you get started using your new camera. It explains the simplest method of operation—with programmed autoexposure, autofocus, and auto-switchover flash. Details on each of the camera's functions begins on p.31 in the section entitled "Operation in Detail".

## MAIN SWITCH/EYE-START

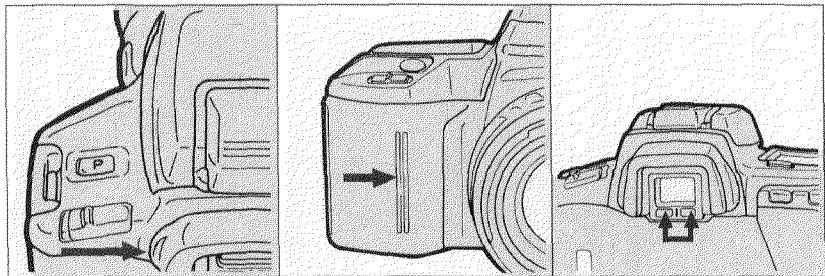

When you slide the main switch to ON, the data panel and grip sensor activate. When you then touch the grip sensor, the eyepiece sensor is activated. This sensor then immediately activates autofocus, autoexposure, and auto-switchover flash when it detects an object near the viewfinder. If you are using an xi-Series Autozoom lens, auto stand-by zoom (ASZ) is also activated by Eye-Start and the lens will zoom automatically. By the time you frame your subject, therefore, the camera has performed many of its set-up operations and is ready to make an exposure. The eyepiece sensor also turns autofocus and autoexposure off when it no longer detects an object near the viewfinder; the last exposure setting will remain in the body data panel for four seconds.

- If you do not touch the grip sensor or if you are wearing gloves, you must activate autofocus and autoexposure by pressing the shutter-release button partway down. ASZ will not function in this case.
- If you are wearing sunglasses which absorb infrared light, Eye-Start may not function.

## HOLDING THE CAMERA

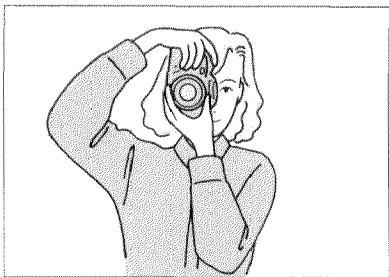
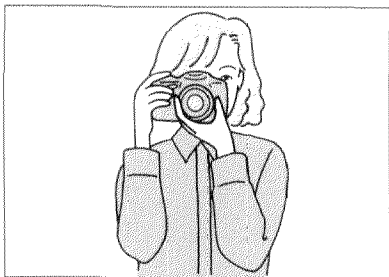

Hold the grip firmly in your right hand and use your left hand to support the camera or lens. Keep your elbows securely against your sides when shooting both horizontal and vertical pictures. Press the shutter-release button gently in a single, steady motion—never with a quick jab. Always keep the camera strap around your neck or wound around one wrist.

- When you pick up the camera, make sure you touch the grip sensor. Otherwise, Eye-Start will not function.
- Do not touch the focusing ring of an AF lens or the end of the lens barrel of an xi-series autozoom lens.

### Camera-shake warning

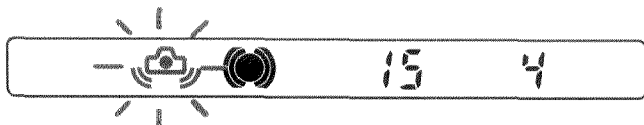

When your subject or scene is too dark to allow a clear hand-held photograph, the camera-shake warning will blink in the viewfinder data panel. You should either raise the built-in flash by pushing the flash-control button or consider using a tripod.

- In S and M mode, the camera-shake warning will not function.

## TAKING PICTURES

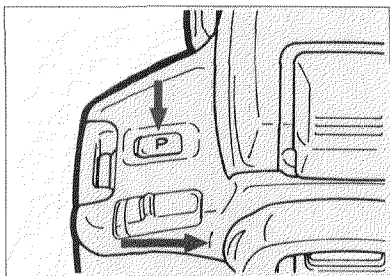



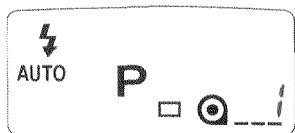

1. Slide the main switch to **ON**.
2. Press the program-reset button to set full-automatic operation.
  - Pressing the program-reset button sets the camera to programmed autoexposure mode, autofocus, and auto-switchover flash. It also resets exposure compensation and self-timer.
3. Hold the camera as described on p.23.
4. Place your main subject in the focus frame and press the shutter-release button all the way down to take the picture.



After the exposure has been made, the camera will automatically advance the film to the next frame and will increase the film counter by one.

## Focus signals



When the camera is activated, either by Eye-Start or by pressing the shutter-release button partway down, the AF system immediately begins measuring subject distance to ensure a sharply focused image. One of the following focus signals will be displayed in the viewfinder data panel:

Signal	Meaning
	Focusing
	Continuous AF mode: focus is confirmed
	Focus is locked (see p.26)
 [blinking]	Focus cannot be confirmed

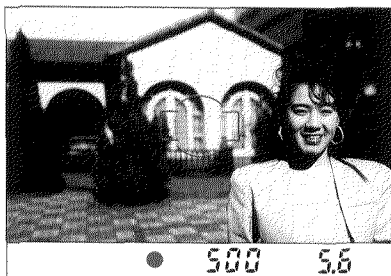
- This camera has Predictive AF. When you take a picture in continuous AF mode, the camera will calculate where the main subject will be when the shutter actually begins to make the exposure, and it will set the lens to focus on this point before the mirror swings up. Extremely fast-moving subjects or subjects which are rapidly changing speed or direction, however, may exceed the capabilities of this system.



If, as a result of the composition or framing you have chosen, the main subject falls outside the focus frame, first lock focus on your subject, then recompose the scene as desired.

1. Place your subject in the focus frame.
  2. Press the shutter-release button partway down.
  3. Make sure you wait for the focus signal to change from  to , then recompose the picture, and press the shutter-release button all the way down to take the picture.
- Focus lock will not work if your subject is moving.
  - Exposure will also lock when shutter-release button is pressed partway down.

## Focus lock with the lens control ring:

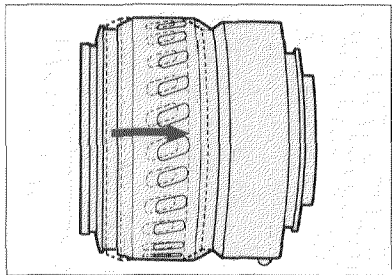

If you are using an xi-Series or power zoom lens, you can lock focus by pulling the lens control ring towards the camera. Hold it in this position while you recompose and take the picture. Do not turn the ring after you lock focus.



## PROGRAMMED AUTOEXPOSURE (P)

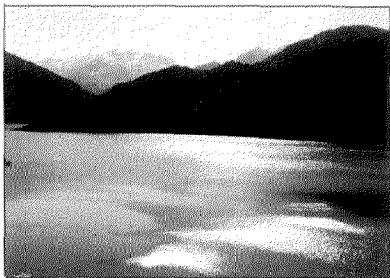

P mode is designed to be the camera's primary exposure mode and is ideally suited for almost all situations. Expert Program Selection analyzes the scene, taking into account motion and magnification as well as lens focal length, and sets both the shutter speed and aperture accordingly. It is able to recognize many different photographic situations, landscapes, close-ups, portraits and action shots, and will optimize the exposure settings based on the particular requirements of the situation at hand.

- If the aperture and shutter speed displays blink in the viewfinder and body data panels, then the required exposure settings are beyond the range of the camera and lens.
- If the metering indicators ▶ ◀ blink in the viewfinder data panel, the lighting is beyond the range of available apertures and shutter speeds.

### Auto-switchover flash (P mode)

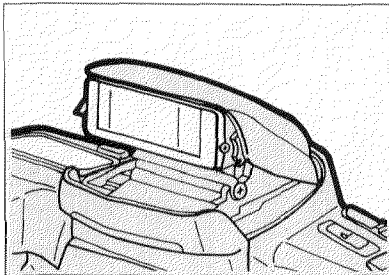
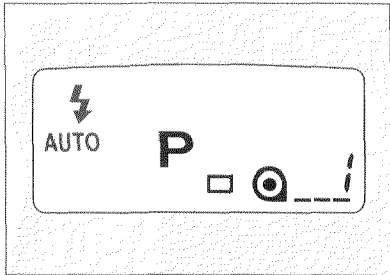



With programmed autoexposure (P mode), the camera begins measuring the light level of your subject and the surrounding scene as soon as Eye-Start activates the camera. If it determines that flash is required, the built-in flash will raise immediately and fire whenever necessary. When the grip sensor is no longer activated, or the main switch is turned off, the built-in flash will automatically lower. To fire flash at any time regardless of lighting, hold the flash-control button down while you take the picture (see manual fill-flash section, p.46).





- If the built-in flash is up and not required, it will not fire when shutter is released, and will lower after you take picture.
- The shutter will lock while the built-in flash is charging to prevent underexposure.

#### **Be careful...**

When using the built-in flash, lens shadowing may occur in your photograph if you are using a lens hood or subject is within one meter of the camera. To prevent lens shadowing, remove lens hood and make sure your subject is farther than one meter away before you take the photograph.

## Viewfinder signals

- The flash-on indicator  appears in the viewfinder data panel to indicate that the flash will fire when the next picture is taken.
- The flash-ready indicator  will appear when flash is fully charged. If pre-flash is selected,  will appear (see next section).
- After shutter is released, if flash output was sufficient to provide correct exposure, the flash-ready indicator will blink.

Viewfinder Display	Meaning
	Flash charging.
	Flash charged (pre-flash not selected)
	Flash charged (pre-flash selected)
 blinking	Flash output sufficient (pre-flash not selected)
 blinking	Flash output sufficient (pre-flash selected)

### Pre-flash

In photos of people, sometimes the subject's eyes appear to glow bright pink or red. This is caused by light from the flash reflecting from the retina of the eyes into the lens. This camera has a pre-flash feature which reduces "red-eye". In pre-flash mode when you press the shutter-release button all the way down, the flash will fire a series of small bursts before the main burst. This causes your subject's pupils to close slightly and greatly reduces the amount of light which will reflect off the retina.

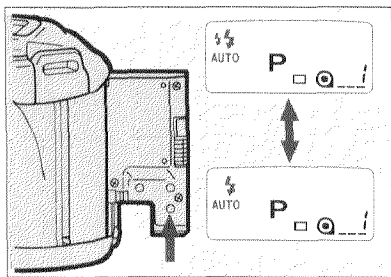

#### To select pre-flash:

Open the card door and press the pre-flash button once so that "  " appears in the body data panel. The pre-flash will fire before every flash exposure.

#### To cancel pre-flash:

Open the card door and press the pre-flash button again; "  " will appear in the body data panel.

- Pressing the program-reset button will not cancel pre-flash.
- When you use pre-flash, warn your subject before you take the picture that the flash will fire several times so that they know what to expect.
- The built-in flash also acts as the camera's AF illuminator. Canceling pre-flash **will not** cancel the AF-illuminator flash. See p.32 for details.

# **OPERATIONS IN DETAIL**

## Autofocus illuminator

In low-light and when subject contrast is too low to be read by the autofocus sensors, the built-in flash will automatically fire a series of low-power bursts when you press the shutter-release button partway down. This provides focus-assist lighting for the AF system to operate normally even in complete darkness.

### To cancel AF illuminator:

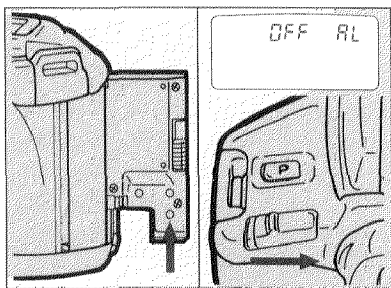

Press and hold the pre-flash button down while you slide the main switch from **LOCK** to **ON**.

"OFF RL" will appear in the body data panel.

- To re-activate the AF illuminator, repeat the above procedure. "On RL" will appear in the body data panel.
- The AF illuminator will not work in P mode if the flash is not necessary or if you have canceled it, or in A, S, or M mode if the flash is down.
- Canceling pre-flash will not affect the AF illuminator.
- The range of the AF illuminator is approximately 1-5m (3.3-16.4ft.).

## Special focusing situations

The camera's autofocus system will produce sharp pictures in almost every situation. In the cases described below, however, it may be difficult or impossible for the camera to autofocus properly—manual focusing may be necessary (see p.34).

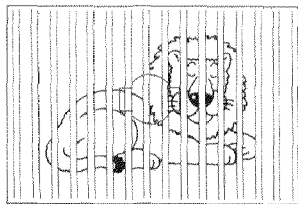

If two subjects at different distances overlap within the focus frame

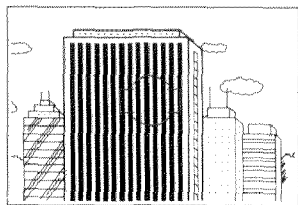

If a subject composed of alternating light and dark lines completely fills the focus frame

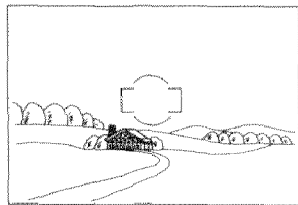

On very bright or low-contrast subjects

- You can also first lock focus on another object of equal distance and then recompose your picture (see p.26).

## Manual focus

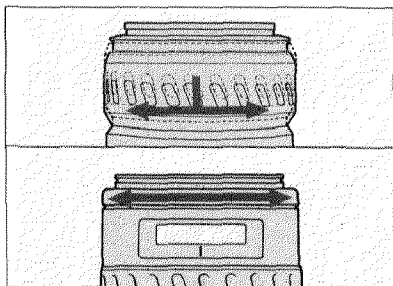
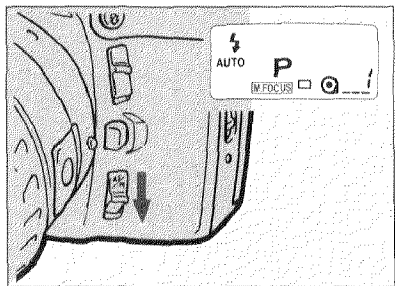

### To manually focus the lens:

1. Slide the focus-mode switch down to set the camera to manual focus mode.

**M.FOCUS** will appear in the body data panel.

2. If you are using an xi-Series lens or AF power zoom lens, pull and turn the control ring. With an AF lens, turn the focusing ring until the subject appears sharp. For more information, refer to the lens manual.

- When your subject comes into focus, ● will light in the viewfinder.
- To return to autofocus mode, slide the focus-mode switch down.
- Pressing the program-reset button will return the camera to autofocus mode and will also change all of the programmable functions to their default settings.
- In manual focus mode, the shutter will release even if the subject is not in focus.



## PA/PS: Creative program control

The camera's Expert Program Selection will determine the best combination of shutter speed and aperture for almost any scene or situation. If, however, you would like to temporarily use a different shutter speed or aperture, Creative Program Control allows you to do so.

### To select PA or PS:

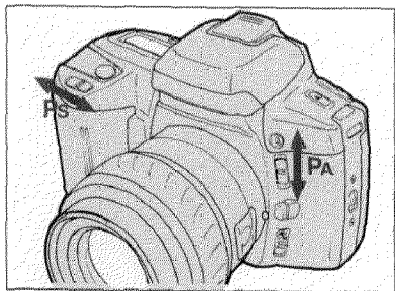

While in P mode, simply slide the aperture-setting control for PA or shutter-setting control for PS to select a different aperture or shutter speed. PA or PS will appear in the body data panel.



- If **P** appears in the viewfinder data panel, Creative Program Control will not function until you cancel the flash or the flash is no longer necessary.
- The camera will return to P mode automatically 4 sec. after it no longer detects an object near the viewfinder.
- To return to P mode, press the program-reset button; to return to P mode and keep any changes you have made to the camera's programmable functions, press the flash-control button.
- The flash will not fire manually or automatically while you are in PA or PS.
- The shutter-speed or aperture display will blink if the subject is too bright or too dark. Slide the aperture or shutter-setting control until neither display is blinking.
- If the metering indicators **▶** **◀** blink in the viewfinder data panel, the light level is beyond the range of available apertures and shutter speeds.

## Changing exposure mode

The camera has four exposure modes: programmed autoexposure (P, PA/Ps), aperture-priority autoexposure (A), shutter-priority autoexposure (S), and manual exposure (M). In P mode, Expert Program Selection automatically evaluates such factors as subject distance, brightness, and movement as well as focal length before it sets aperture and shutter speed. It will then optimize the exposure settings based on the particular requirements of the situation at hand. There is no single program line for each focal length, and no special modes to set manually for different situations.

If you want more creative control over the camera's exposure settings, use A, S, or M mode. Each mode is explained in following sections.

### To change exposure mode:

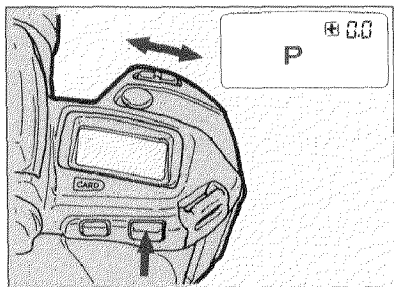

1. Press and hold the function button while you slide the shutter-setting control.

2. When you release the function button, the mode you have selected will be entered automatically.

- Pressing the program-reset button returns the camera to **P** mode and resets the camera's programmable functions to their default settings.

## A: Aperture priority

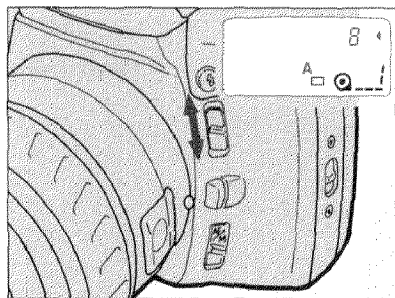
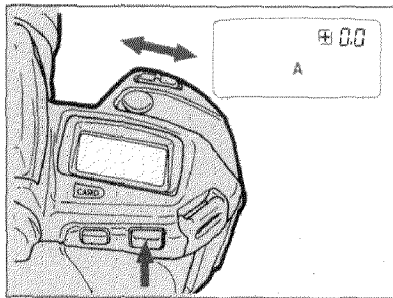

This mode allows you to set the aperture you want, giving you greater depth of field control (see p.58). If the shutter speed is available, the camera will automatically select it to maintain a correct exposure.

1. Refer to p.36 (Changing exposure mode) and select **A**. A pointer will appear next to the aperture display.
2. To select the aperture, slide the aperture-setting control up or down.
  - The aperture display in the data panels will change in 1/2-stop increments.
  - Available apertures are limited to those within the range indicated on the lens you are using.
  - The shutter speed display will blink if the required speed is beyond the range of the camera. If "2000" blinks, slide the aperture-setting control down to set a smaller aperture (larger f-number); if "30" blinks, slide the aperture-setting control up to set a larger aperture (smaller f-number).
  - If the metering indicators ▶ ◀ blink in the viewfinder data panel, the lighting is beyond the range of available apertures and shutter speeds.

### S: Shutter priority

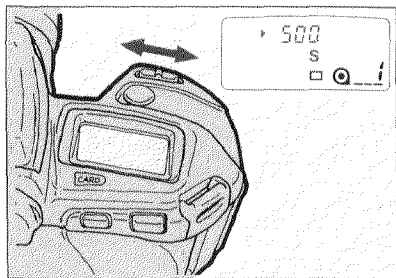
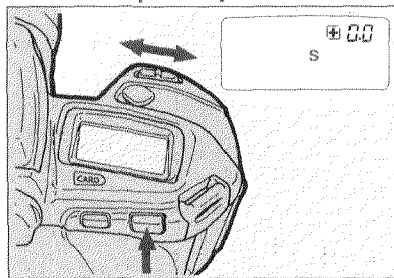

This exposure mode lets you select a shutter speed and allows you to control image blur (see p.60). If the lens you are using allows, the camera will automatically set the correct aperture to ensure a proper exposure.

1. Refer to p.36 (Changing exposure mode) and select **S**. A pointer will appear next to the shutter speed display in the body data panel.
2. To select the shutter speed, slide the shutter-setting control to the left or right.
  - The shutter-speed display in the data panel will change in 1-stop increments.
  - If the aperture display blinks, the aperture required to provide correct exposure at the shutter speed you have selected is not available. If the lens' maximum aperture blinks, slide the shutter-setting control to the left, decreasing the shutter speed; if the minimum aperture blinks, slide the shutter-setting control to the right, increasing shutter speed.
  - If the metering indicators ▶ ◀ blink in the viewfinder data panel, the light level is beyond the range of available apertures and shutter speeds.
  - You cannot select **bulb** in **S** mode.

## M: Manual exposure

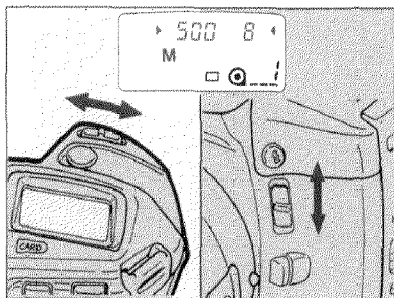
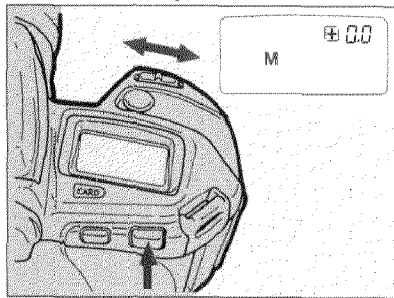

In manual exposure mode, you have full control over the exposure settings. You select the shutter speed and aperture and the camera will tell you whether your settings will provide an over-, under-, or correctly-exposed picture.

1. Refer to p.36 (Changing exposure mode) and select **M**. Pointers will appear next to both the shutter speed and aperture displays in the body data panel.

2. To select the shutter speed, slide the shutter-setting control to the right or left. To select the aperture, slide the aperture-setting control up or down.

- The shutter speed will change in 1-stop increments and the aperture will change in 1/2-stop increments.

### Viewfinder exposure signals:

Viewfinder Signal	Meaning
250 ▶ ◀ 5.6	Exposure is set correctly.
80 ▶ ⊕ 5.6	Overexposure.
500 ⊖ ◀ 5.6	Underexposure.
2000 ▶ ◀ 2.2	The light level is beyond the meter's range.

In manual mode, the above displays in the viewfinder data panel will relate information regarding your settings.

## Bulb: Long exposures

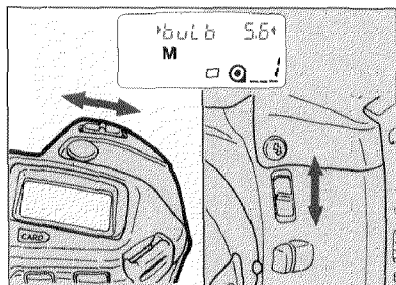
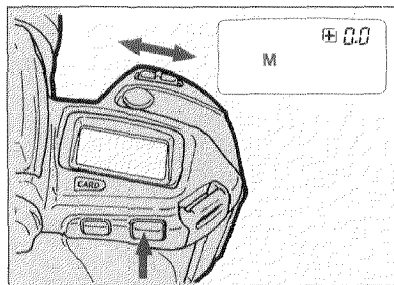

The **bulb** shutter-speed setting can be used for making exposures of longer than 30 seconds duration. Long exposures are appropriate for photographing a variety of subjects, including fireworks, lightning storms, city skylines after sunset, etc. When you select **bulb**, the shutter will remain open as long as you hold the shutter-release button down.

### To use bulb setting:

1. Mount the camera on a tripod.
2. Set the exposure mode to **M** (manual).
3. Slide the shutter-setting control to the left until **bulb** appears in the data panel. Use the aperture-setting control to select the aperture.
4. Compose your scene and focus the lens.
  - If the scene is too dark, autofocus may not function. Slide the focus-mode switch down and focus the lens manually.

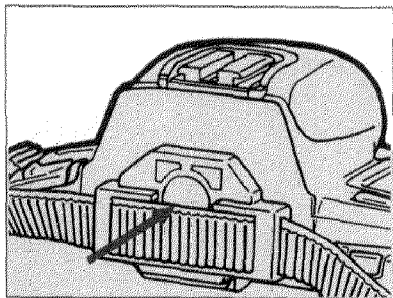

5. Attach the eyepiece cap to prevent stray light from entering the camera and affecting the exposure.
6. To take the picture, press the shutter-release button and hold it down for the duration of the exposure. The shutter will remain open as long as you hold the shutter-release button down.

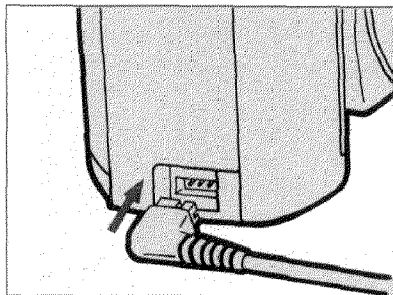

- To prevent camera shake, attach Remote Cord RC-1000S or RC-1000L. Open the card door, remove the remote-control terminal cover and insert the remote cord's plug into the terminal. The shutter will remain open as long as you hold the remote-control button down.

## Spot metering

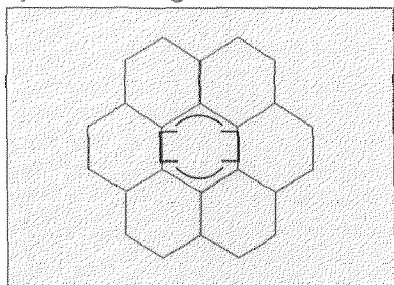

**Honeycomb Pattern**

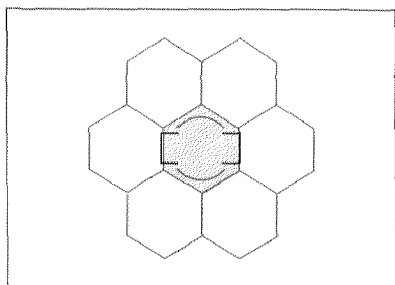

**Spot**

The camera's standard metering mode is AF-integrated, 8-segment Honeycomb-Pattern Metering, which will provide correct exposure in almost all situations. Spot metering can be manually selected, in which case, the center segment in the honeycomb pattern is used exclusively to measure the subject's light level.

If your scene is extremely contrasty or if you are using a reference subject for metering, spot metering will help you obtain consistent, precise exposure readings of the spot-metering area. Spot metering is selected on a temporary basis only. It is activated by holding down the spot-metering button and its measured exposure is retained as long as the spot-metering button is held in; once the spot-metering button is released, honeycomb-pattern metering is restored.



## To use spot metering:

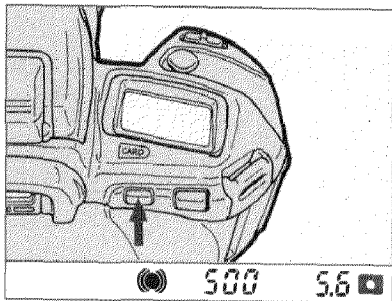

1. Place the spot-metering frame over the area you want to meter.
2. Press and hold the spot-metering button.  will appear in the viewfinder.
3. Continue to hold the spot-metering button, recompose your scene, and press the shutter-release all the way down to take the photograph.

- If you have to move closer to your subject to make it fill the spot-metering frame, or if the area you meter is not the same distance from the camera as your main subject, first lock focus on your subject and proceed with step 1, keeping focus locked throughout the following steps.
- Be sure that you spot meter an area which will appear as a midtone or average brightness in your final picture.
- When you are using flash, you cannot use spot metering. In P, A, or S modes with the flash on, pressing the spot-metering button activates slow-shutter sync. (see p.48).

## Exposure compensation

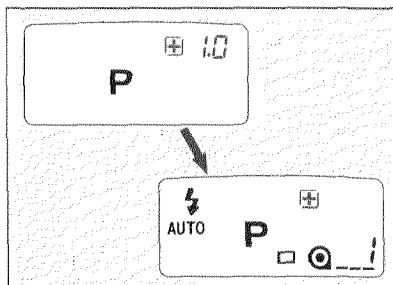
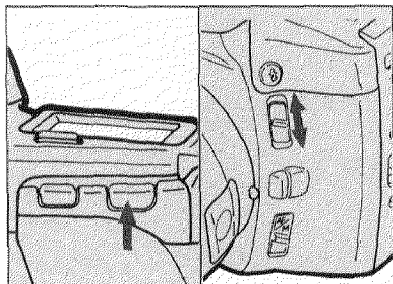

This function enables you to intentionally under- or overexpose the image up to  $\pm 4$  stops in 1/2-stop intervals.

### To set:

Press and hold the function button while sliding the aperture-setting control up for increased exposure adjustments, and down for decreased exposure adjustments until the compensation figure you want appears in the viewfinder and body data panels.

- After you release the function button, your selection will be entered automatically.
- After you enter the compensation factor, the number will disappear but  $\oplus$  or  $\ominus$  will remain as a reminder that an adjustment has been made. To check the amount of compensation at any time, press the function button. The compensation figure will again appear in the viewfinder and body data panels.

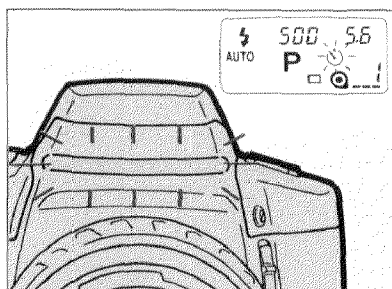
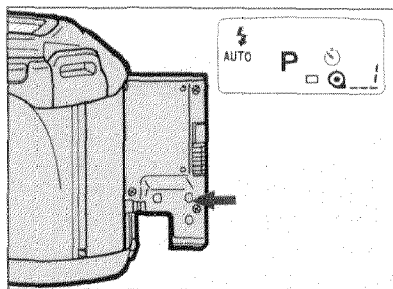

When you have finished using exposure compensation, cancel it by setting 0.0 adjustment.

- Pressing the program-reset button will cancel any exposure compensation and return all the camera's programmable functions to their default settings.



The electronic self-timer will delay release of the shutter until approximately 10 seconds after you press the shutter-release button.

### To activate the self-timer:

1. Open the card door and press the self-timer/drive-mode button once.  will appear in the body data panel.
2. Compose your scene and attach the eyepiece cap.
3. Press the shutter-release button all the way down to start the timer.
  - To show that the self-timer is operating,  in the body data panel blinks until the shutter releases.
  - The self-timer-indicator window flashes three times right before the shutter releases.
  - If the built-in flash is up when the self-timer is activated, it will lower when the shutter release button is pressed, and if flash is still needed, it will raise right before the picture is taken.
  - The self-timer can be stopped during countdown by sliding the main switch to LOCK.
  - Pressing the program-reset button will cancel the self-timer and return all the camera's programmable functions to their default settings.
  - The self-timer automatically switches off after the picture is taken. To make another exposure with the self-timer, repeat steps 1-3.

## FLASH DETAILS

This camera uses a TTL (through-the-lens) flash metering system to control the flash output for proper exposure. Also, to provide necessary flash coverage for the current lens focal length, the built-in flash automatically zooms between 28mm and 80mm.

- The built-in flash or an accessory flash will not fire while the camera is set to Creative Program Control (PA/PS).

### Manual fill-flash (P mode)

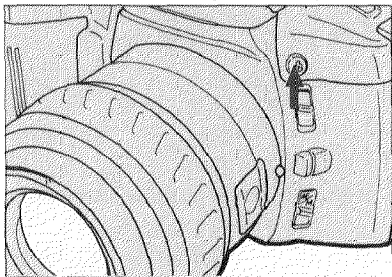

In P mode, the built-in or an attached, dedicated flash will fire whenever necessary, unless the dedicated flash is turned off. To fire the flash manually in P mode, regardless of lighting conditions, press and hold the flash-control button while you press the shutter-release button all the way down.

### Flash cancel (P mode)

**To prevent built-in flash from firing in P mode:**

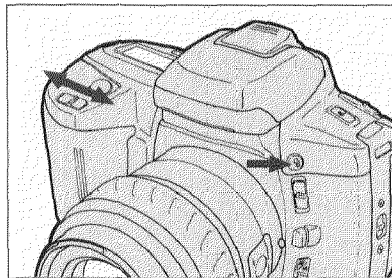

Press and hold the flash-control button while you slide the shutter-setting control. The flash-mode indicator will disappear from the body data panel.

- To restore auto-switchover flash, press the flash-control button or press the program-reset button. The flash-mode indicator will appear in the body data panel.

- If you have canceled the flash and the shutter speed is too slow to allow sharp pictures while hand-holding the camera, the camera-shake warning (📷) will blink in the viewfinder data panel. Mount the camera on a tripod or activate the flash.

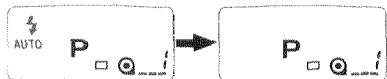

## A, S, and M mode flash

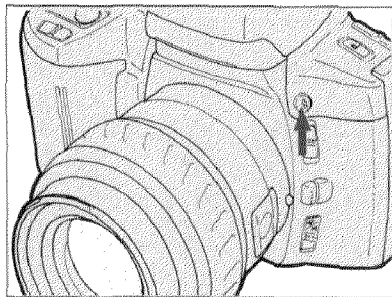

In A, S, or M mode, if the flash is down it will not fire; if the flash is up, it will fire every time you take a picture. To activate the built-in flash, press the flash-control button; it will not raise automatically. When flash is no longer wanted, press the flash-control button once more, flash will lower and cancel.

In S mode, the shutter speed and aperture will be set automatically by the camera. In A and M mode, you can set any aperture within the lens' range. In M mode, you can select any shutter speed between 1/90 sec. and 30" sec., as well as bulb.

- Pre-flash and remote/wireless off-camera control can be selected in any of these modes.

- For chart of viewfinder flash signals, see FLASH BASICS, p.29.

### Flash range (Film speed:ISO100)

Focal Lengths Aperture	28-50mm	50-80mm	80mm-
2.8	1.0-5.0m 3.3-16.4ft.	1.0-5.4m 3.3-17.8ft.	1.0-6.1m 3.3-20.1ft.
4	1.0-3.5m 3.3-11.5ft.	1.0-3.75m 3.3-12.4ft.	1.0-4.25m 3.3-14ft.
5.6	1.0-2.5m 3.3-8.2ft.	1.0-2.6m 3.3-8.7ft.	1.0-3.0m 3.3-9.9ft.

\* When using ISO 400 film, maximum flash distance is doubled.

## Slow-shutter sync. flash

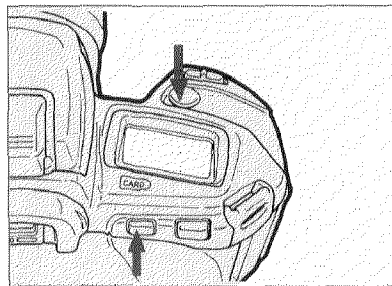

The slow-shutter sync option will set a slower shutter speed to increase the background exposure in a flash picture. Flash output will be decreased automatically to maintain a correct exposure of your subject. It can be used in P, A and S modes.

1. Press and hold the spot-metering button.
2. While continuing to hold the spot-metering button, press the shutter-release button all the way down.

- While spot-metering button is being pressed,  will appear in the viewfinder data panel.
- If the background is bright or a large aperture is set, the shutter speed may not be reduced.
- The flash-ready indicator in the viewfinder data panel will blink if the flash output was sufficient to provide a correct exposure.

## Remote/Wireless off-camera flash control

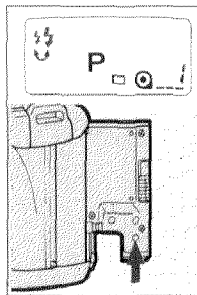
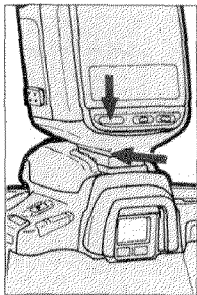
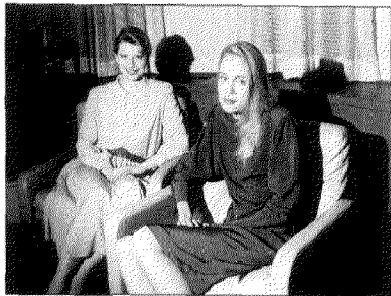

When used with specified xi flash units, this camera offers you the flexibility of remote/wireless off-camera flash control with TTL flash metering. Because the signal that fires the off-camera flash is a small burst from the built-in flash, reduce the brightness of your surroundings as much as possible.

1. Attach the flash to the camera and turn it on.
2. Open the card door and press the pre-flash button to select remote/wireless flash mode. The flash-mode indicator  will blink alternately in the body data panel.

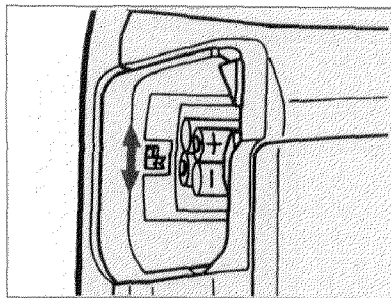

The flash unit has more than one control channel so that if you are working near someone who is using a similar set-up, you will not interfere with each other. The flash must be mounted on the camera when you change the control channel.

- To change the control channel, slide the control channel selector in the battery chamber of the flash.

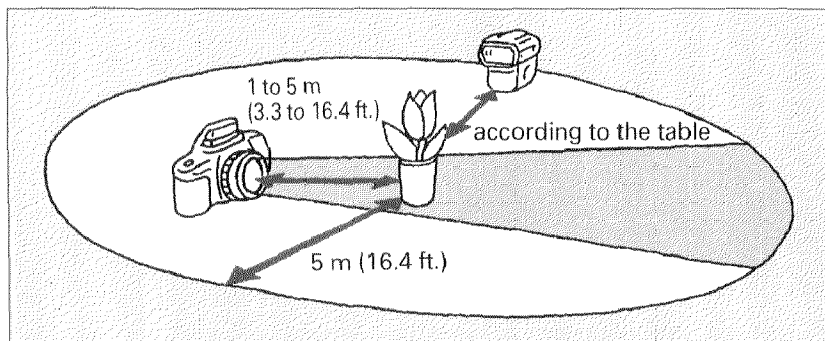

3. Remove the flash and place it 40cm to 5m (16in. to 16.4ft.) from the subject with its AF illuminator pointing at the subject.

- The camera should be 1 to 5m (3.3 to 16.4ft.) from the subject.
- The off-camera flash may not detect the control signals if it is placed behind the subject. To increase the ability of the flash's built-in sensor to detect the control signals, reduce the surrounding light level as much as possible.
- The off-camera flash and built-in flash will not zoom automatically; initially, both are set to 28mm.

### Flash Range:

Film speed Aperture	ISO100	ISO400
2.8	1–5m/3.3–16.4ft.	2–5m/6.5ft–16.4ft
4	0.7–4.5m/2.3–14.7ft	1.4–5m/4.5–16.4ft
5.6	0.5–3.2m/1.6–10.4ft	1–5m/3.3–16.4ft



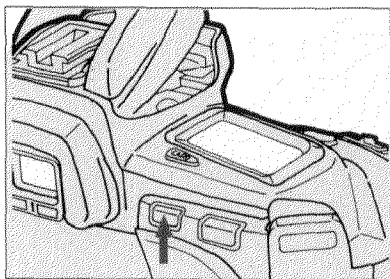
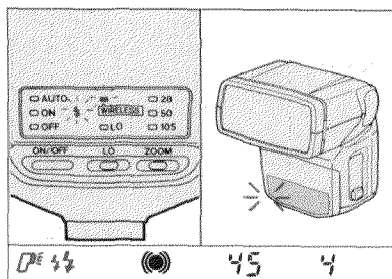

4. Wait until both the off-camera flash and built-in flash are charged.

- In remote/wireless mode, the off-camera flash's AF illuminator will blink when the flash is charged. When the built-in flash is charged, ⚡ will appear and blink alternately in the camera's viewfinder data panel.

5. Without activating the eyepiece sensor, press the spot-metering button to test-fire the off-camera flash and wait again until both flashes are fully charged.

- If the eyepiece sensor is activated, the off-camera flash will not test-fire.

6. Take the picture.

- The flash-ready indicator in the viewfinder data panel will blink if the flash output was sufficient to provide a correct exposure.

- To temporarily cancel remote/wireless off-camera control, press and hold the flash-control button while you slide the shutter-setting control.

The remote/wireless flash-mode indicator ⚡ will disappear from the body data panel. To return remote/wireless mode, press the flash-control button.

- To cancel remote/wireless off-camera control, press the program-reset button or the pre-flash button. Pressing the program-reset button returns all functions to their original default settings.

### Remote/Wireless slow-shutter sync.

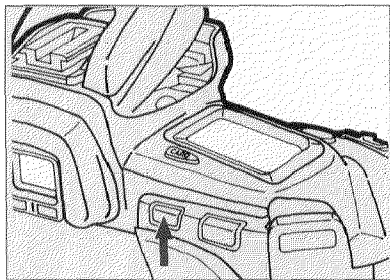

In remote/wireless slow-shutter sync mode, the camera sets a slow shutter speed and reduces the flash output to maintain a correct exposure. Operation is the same as it is with the built-in or an attached flash (explained on p.48).

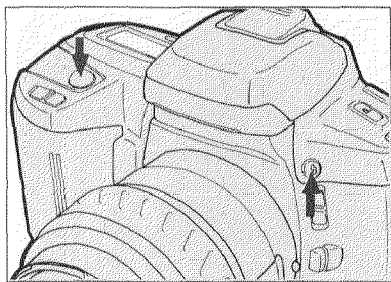

- To set slow-shutter sync. without test-firing the off-camera flash first, activate the eyepiece sensor before you press the spot-metering button.

### Ratio control

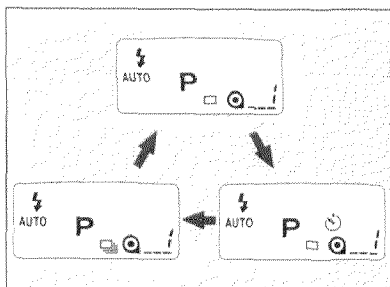
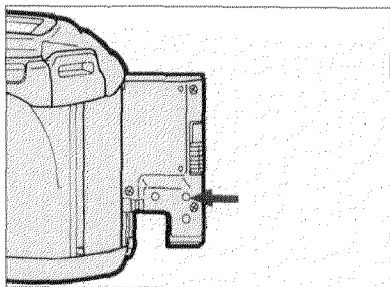

In remote/wireless mode, the off-camera flash and built-in flash can work together to provide a 2:1 lighting ratio on your subject. Simply press the flash-control button and hold it while you take the picture. The off-camera flash will provide 2/3 of the exposure and the built-in flash will add the remaining 1/3.



The camera gives you a choice of two film-advance modes. In single-frame mode  , the film is advanced one frame each time you press the shutter-release button. In continuous mode  , successive exposures are made and the film is advanced continuously at one frame per second. When you operate the camera in continuous mode, with autofocus set, the focus setting will be checked and adjusted between each exposure to ensure that subjects remain sharply focused.

### To select the film-drive mode:

Open the card door and press the self-timer/drive-mode button until the indicator for the mode you want appears in the body data panel.

- Pressing the program-reset button will return the camera to single-frame advance and return all of the camera's programmable functions to their default settings.
- When the film drive is set to continuous mode, power zoom will not operate.

# AUTOZOOM SYSTEM

With an xi-Series Autozoom lens, the camera's automatic control extends to control over zooming the lens. This speeds operation of the camera and lens and allows you to concentrate more fully on the composition of your photographs. **The following features are available only when you are using an xi-Series Autozoom lens.**

## Auto stand-by zoom (ASZ)

When Eye-Start first activates the camera, the lens immediately sets a focal length. This position is determined by the subject's distance from the camera and should provide a good starting point in your composition. The focal length can also be quickly adjusted from this point.

- ASZ's operation is a one-shot function; it will not set a new focal length every time you point the camera at a new subject unless you first take the camera away from your eye. If you use power zoom to change ASZ's setting, ASZ will not function again until you remove the camera from your eye and wait about 20 sec.
- If the grip sensor does not activate Eye-Start, ASZ will not function. In this case, pressing the shutter-release button partway down will activate all of the camera's automatic systems except ASZ.

### To cancel ASZ:

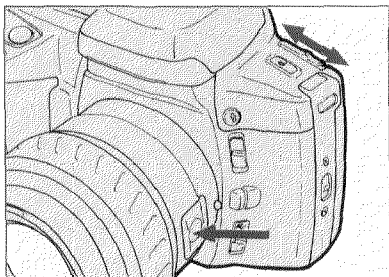

1. Set the main switch to LOCK.
  2. Press and hold the lens-function button on the lens barrel while you slide the main switch to ON.
- To turn ASZ on again, repeat the above steps.

OFF AS

## Image-size lock

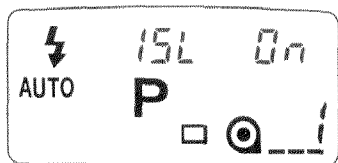
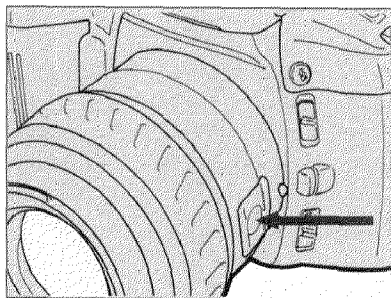
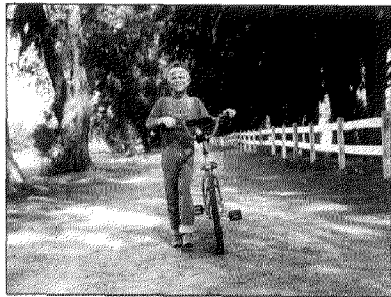

When you press the lens-function button on an xi-Series lens, the size of the main subject's image will be locked. While you hold the button, the camera automatically adjusts the lens' focal length to maintain the size of the main subject's image. When image-size lock is activated, "ISL On" will appear in the viewfinder and body data panels until you press the shutter-release button partway down, it will then be replaced by shutter-speed and aperture settings.

Image-size lock is limited by the focal length range of the lens you are using. If, while image-size lock is operating, either end of the lens focal length range is reached, the lens will stop zooming. If your subject comes back into range, image-size lock will resume operation. To turn off image-size lock, release the lens-function button.

- If it becomes impossible for the camera to maintain the same image size, Image-Size Lock will stop functioning. If your subject moves back into range, the camera will resume tracking it.
- Image-Size Lock may not be able to accurately track high-speed subjects and the image size may not remain constant.

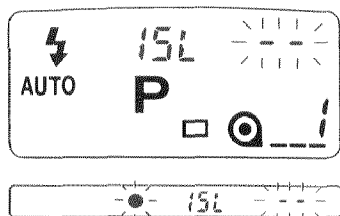

In the following situations, "15L -- [flashing]" will appear in the viewfinder data panel when you press the lens function button and Image-size lock will not function:

- If your subject is too small and/or too far away for the camera to lock on to it
- If the camera cannot focus on your subject (see Special focusing situations p. 33)
- If the lens is initially set to a focal length shorter than 50mm

# APPENDIX

## LENS APERTURE AND DEPTH OF FIELD

Depth of field is the area in front of and behind the point on which the lens is focused which will also appear acceptably sharp in the final image. Aperture size, focal length, and subject distance are important factors in determining this range.

Aperture size is commonly expressed as an f-number or f-stop. These are the numbers that are displayed in the data panels and which appear as part of the lens designation. An f-number is inversely related to the actual size of the aperture. For this reason,  $f/8$  is larger than  $f/11$ , but smaller than  $f/5.6$ .

The whole-stops and half-stops between  $f/1.4$  and  $f/32$  are listed below. Depending on which way you move on the scale, a change of one stop, either from whole-stop to whole-stop or from half-stop to half-stop, will double or halve the amount of light reaching the film, depending on which way you move on the scale.



←-----more light-----less light-----→  
1.4 1.7 2 2.4 **2.8** 3.5 4 4.5 **5.6** 6.7 8 9.5 11 13 **16** 19 **22** 26 32

\*Whole stops are in bold type



small aperture

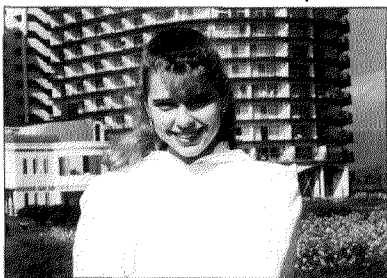

large aperture

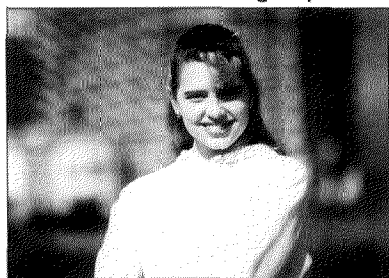

If focal length and subject distance remain constant, as the size of the lens aperture decreases, depth of field increases. Aperture-priority (A) mode, and manual (M) mode enable you to vary the size of the aperture in order to directly control a picture's depth of field. Different situations usually require different amounts of depth.

For example, in a portrait situation, you may want to use a larger aperture in order to focus only on the main subject and separate the person from their background. A small aperture, on the other hand, would be preferable in such cases as landscape photography when you want as much of the scene as possible to appear in focus. Expert Program Selection will automatically set a large aperture in portrait situations so that only your main subject will appear in sharp focus, and a small aperture for landscapes and extreme close-ups to maximize depth of field.

For any given f-number and subject distance, an increase in focal length will reduce the depth of field and a decrease in focal length will have the opposite effect. For example, if a 28-80mm zoom lens is set at 50mm, f/8 and the subject is 12 ft.(3.6m) away, changing the focal length to 80mm without altering the exposure settings or subject-to-camera distance will noticeably shorten the depth of field. Setting the lens to 28mm, however, extends the range which will appear in focus.

Depth of field also depends on subject distance. Without changing lens aperture or focal length in the above case, if you move to 6 ft.(1.8m) from your subject, there will be less depth of field in the final image.

## SHUTTER SPEED AND MOVING SUBJECTS

slow



fast



Your choice of shutter speed is an important factor in determining how moving subjects will appear in the final image. Depending on the speed of your subject, slower shutter speeds such as  $1/15$  sec. will make moving subjects appear blurred and flowing in the picture, creating a greater feeling of motion. Fast shutter speeds, of course, are useful to freeze fast action.

Also, if you are using a telephoto lens, a fast shutter speed can help prevent blurring caused by camera shake. For lenses longer than  $f' = 50\text{mm}$ , a general rule to follow is that  $1/f'$  is the slowest usable shutter speed while the camera is being hand-held. For example, if you are using a 135mm lens, try to avoid using shutter speeds slower than  $1/180$  sec. (the closest shutter speed to  $1/135$ ) if you are not using a tripod.

## ACCESSORY INFORMATION

If you already have own MINOLTA accessories, check their compatibility before using them with your 5xi.

### Creative expansion cards

This camera can use Creative Expansion Cards: all of the Special Application Cards and three of the Feature Cards. Special Application Cards tailor the camera's operation to specific situations and provide fully automatic operation, and Feature Cards add extra features for advanced camera control.

The Creative Expansion Cards that can be used with this camera are listed below. Settings must be made with the shutter-setting control.

#### Special Application Cards

Travel\*1

Child\*2\*3\*4

Automatic depth control

Sports action

Portrait

Closeup

#### Feature Cards

Multiple exposure\*5\*6

Exposure bracketing\*7

Flash bracketing\*8

\*1 When using the Travel Card with the 5xi, shutter speeds do not increase when photographing from a moving car or train.

\*2 In single-frame or continuous mode, APZ will lock when the shutter-release button is pressed partway down. Power zoom can be used for additional zooming.

\*3 When power zoom is used, APZ will not operate until the eyepiece sensor is no longer activated and the exposure values disappear from the data panel.

\*4 The selected APZ program number will remain in the data panel for four seconds.

\*5 When the camera is in M mode, it cannot vary the apertures for fade-in/out.

\*6 If the battery is changed while the card is activated, the card will be canceled, and the film advanced to the next frame.

\*7 It cannot vary the apertures in M mode.

\*8 When Eye-Start is not activated and you remove your finger from the shutter-release button, the next frame number and exposure-adjustment step appears.

## (Accessory information)

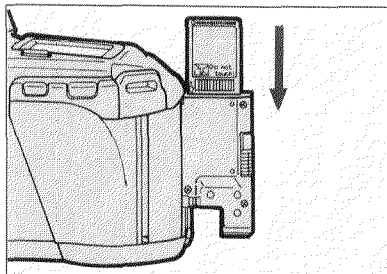
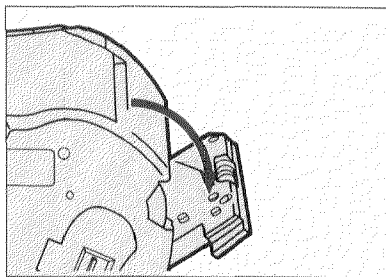

### To insert the card:

1. Set the main switch of the camera to ON.
  2. Open the card door.
  3. Insert the card into the slot at the top of the card door with the card contacts facing you. The card indicator will appear in the body data panel, if not, check the direction of the card.
  4. Close the card door.
- To cancel the function of this card while card is inserted, press card on/off key. The card indicator will disappear from the data panel.

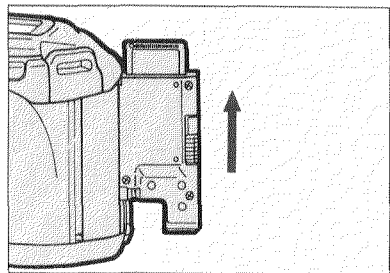

### To remove the card:

1. Open the card door.
2. Push the card-eject slide up and pull the card up out of the slot.

## Lens

All Minolta AF lenses can be used with 5xi. Autozoom functions (ASZ, APZ, Image-size lock) are possible only if the 5xi is used with an xi-Series lens.

Manual focusing lens (MD or MC) cannot be attached the 5xi.

Shadowing on the bottom of picture may occur in your pictures when the 5xi's built-in flash is used together with a lens listed below. Before using any of these lenses, check with the nearest Minolta Service facility for the conditions of their use:

AF28-85mm f/3.5-4.5      AF28-135mm f/4-4.5

The following lenses cannot be used under any conditions with the 5xi's built-in flash:

AF300mm f/2.8 APO TELE      AF300mm f/2.8 APO TELE(N)

AF600mm f/4 APO TELE      AF600mm f/4 APO TELE(N)

Keep in mind, too, that the built-in flash provides coverage for lenses with focal lengths' no wider than 28mm. The above information applies only to use with the 5xi's flash.

Macro AF 3x-1x Zoom lens:

Before attaching/removing the lens to the camera, set any lens' magnification other than 1x.

## Flash

Minolta "i" and "xi" Series flashes can be used.

Flash Shoe Adapter FS-1100 must be used to attach an AF-Series flash to 5xi. When used with the 5xi, these units fire whenever a picture is taken, regardless of the exposure mode selected.

In all exposure modes TTL flash control will operate.

## CARE AND STORAGE

- Always keep your camera in its case with lens capped when not in use, or with a body cap on when a lens is not attached.
- No part of the camera should be forced at any time.
- 72-exposure cartridge and polaroid instant 35mm films cannot be used.
- Never subject your camera to shock, high heat, humidity, water, or harmful chemicals. Be particularly careful not to leave it in the glove compartment or other places in motor vehicles where it may be subjected to high temperatures.
- Never lubricate any part of the camera body or lens.
- Never touch the shutter, mirror, or front inside parts of the body or clean them with compressed air. Doing so may impair their alignment and movement.
- External camera surfaces and lens barrel—but not glass surfaces—can be cleaned by wiping with a dry or silicone-treated cloth. Never use organic solvents to clean camera.
- Never touch the lens or eyepiece surfaces with your fingers. Whisk away loose matter with a blower brush. To remove stubborn spots, use a sheet of photographic lens tissue. If necessary, tissue may be moistened with one drop of lens-cleaning fluid. Never place fluid directly on glass surfaces.
- We recommend that you have your camera cleaned once a year at an authorized MINOLTA Service facility.
- If you plan to store your camera for an extended period of time, rewind and remove the film, then remove the battery. Place camera in a cool, dry place away from dust or chemicals, preferably in an airtight container with a drying agent such as silica gel. Also, it is recommended that you periodically release the camera's shutter to maintain proper working condition.

- This camera is not waterproof, dustproof or sand-proof. If you use this camera near water or at the beach, water-, dust-, or sand-damage may occur. Protect it at all times from moisture or splashes, especially saltwater spray, and be extremely careful to keep sand from both the interior and exterior of the camera and its accessories. If it comes in contact with water, wipe it with a clean, dry cloth and bring it to an authorized MINOLTA Service facility. If it comes in contact with sand or if sand enters the camera, gently blow away loose particles--wiping may scratch the camera--and bring it to an authorized MINOLTA Service facility.
- If the camera is subjected to a sudden change in temperature, as when transforming it from a cold environment into a heated building, condensation may form inside. To prevent condensation, place the camera in a sealed plastic bag before transferring it from a cold place to a warm environment, and wait for it to come to room temperature before taking it out of the bag.
- After prolonged storage, and especially before taking pictures at an important event, carefully check the operation of the camera and lens.
- The operating range for the camera's data panel is from  $-20$  to  $50^{\circ}\text{C}$  ( $-4$  to  $122^{\circ}\text{F}$ ). At temperatures outside of this range, response time and contrast will change, making the display difficult to read. At very high temperatures, a display may temporarily darken. If this occurs, the display should return when the camera is restored to operating range conditions.
- This camera contains no user-serviceable parts. Do not attempt to disassemble or repair the camera yourself.
- This camera's circuitry may switch off, even when a battery with sufficient power is installed. To resume operation, remove the battery and install it again.

## TROUBLESHOOTING

When you have a problem, consult the table below. If your problem is not covered here, please contact nearest Minolta Service facility.

PROBLEM	CAUSE	SOLUTION	PAGE
<i>HELP</i> displayed in the body data panel.	Winding motor problem	Remove the battery, then install it. If " <i>HELP</i> " appears again after you release the shutter, take the camera to Minolta Service facility.	13
No display in the data panel.	Battery is insufficient.	Replace the battery.	13
	Battery is not installed correctly.	Install it correctly.	13
"--" appears in the data panel's aperture display.	Lens not attached correctly.	Attach the lens so that it locks in place with a click.	16
	Contacts on camera and lens are dirty.	Clean contacts with a dry, clean cloth.	
	AZ/MZ switch set to MZ.	Slide the AZ/MZ switch to AZ.	16
Autofocus does not work or the lens does not focus when activating Eye-Start.	Camera set to manual focus.	Set the camera to autofocus mode.	34
	AZ/MZ switch set to MZ.	Slide the AZ/MZ switch AZ.	16
	Lens is not attached correctly.	Attach the lens so that it locks in place with a click.	16



Camera will not focus on your subject.	Subject is a special focusing situations.	Focus it manually.	34
Focus is difficult to confirm when taking picture with built-in flash.	Subject is beyond AF illuminator range.	Make sure subject is 1 - 5m (3.3 - 16.4 ft) from the camera.	32
	AF illuminator is canceled.	Press and hold pre-flash button while sliding the main switch from LOCK to ON.	32
Built-in flash does not fire.	Flash is canceled.	Press the flash-control button.	46 47
Shadowing (bottom of picture is dark) occurred with built-in flash.	Lens hood was not removed, when taking picture.	Remove the lens hood when taking picture with built-in flash.	28
	Subject is too close to camera.	Make sure subject is more than 1m(3.3ft) from camera.	28
	Used a lens listed on page 63.	Use accessory flash or another lens.	63
Vignetting (corners of picture are dark) occurred with built-in flash.	Focal length is shorter than 28mm.	Set the focal length longer than 28mm. Built-in flash covers up to 28mm.	

## (Troubleshooting)

Underexposure (picture is dark) occurred with built-in flash.	Subject is beyond flash range.	Check the flash range chart before taking pictures. Make sure flash-ready signal is blinking after the shutter is released.	47
In remote/wireless mode, built-in flash fires, but off-camera flash does not.	Off-camera flash did not receive signal from the built-in flash.	Before taking pictures, test the flash. If off-camera flash does not fire, change the setting.	50
	Channel of the camera is not the same as the off-camera flash.	Attach the flash to the camera and activate Eye-Start or press the shutter release button part way down to set the camera to the same channel as flash.	49
Image-size lock does not work.	Child card is being used.	Press the card button so the card indicator disappears. Remove the child card.	62
Auto stand-by zoom does not work.	Auto stand-by zoom is canceled.	Press and hold the lens-function button while you slide the main switch from LOCK to ON.	54
Exposure mode cannot be changed from P mode.	Creative expansion card is being used.	Press the card button so the card indicator disappears. Remove the card.	62

This camera's circuitry may switch off even when a battery with sufficient power is installed. To resume operation, remove the battery and install it again.

## TECHNICAL DETAILS

**Type:** 35mm SLR with expert control of autofocus (AF), autoexposure (AE), and auto zoom (AZ); also auto film transport and built-in flash

**Lens mount:** Minolta A-type bayonet mount; accepts all Minolta AF lenses, xi-Series Autozoom lenses, and AF Power Zoom lens

**Eye-Start system:** AF, AE, (if using xi-Series lens) ASZ, and built-in flash automatically activated by combination of eyepiece and grip sensors

**AF system:** Minolta's through-the-lens (TTL) phase-detection system with one wide CCD sensor; activated by Eye-Start; Predictive focus control; AF illuminator: built-in flash automatically fires in low-light and low-contrast conditions; AF sensitivity range: EV -1 - 18 (at ISO 100); AF illuminator range: 1-5m (3.3-16.4ft.)

**Manual focusing:** Visually on Acute-Matte viewfinder screen or by monitoring focus signals in viewfinder data panel

**Metering:** TTL-type; Honeycomb-pattern silicon photocell (SPC); automatically activated by Eye-Start; second SPC for TTL flash metering of built-in flash or other dedicated flash unit; metering modes: 8-segment honeycomb-pattern EV 0 - 20, spot metering EV 3-20 (ISO 100, 50mm f/1.4)

### Exposure modes:

Programmed AE: Automatic control of aperture and shutter speed depending on scene characteristics and lens specifications; PA, Ps: Creative Program Control

Aperture-priority AE: Any available aperture selectable in 1/2-stop increments; shutter speed set by autoexposure program

Shutter-priority AE: Any shutter speed from 1/2000 to 30 sec. selectable in 1-stop increments; aperture set by autoexposure program

Manual: Any aperture selectable in 1/2-stop increments; any shutter speed selectable in 1-stop increments; bulb also available; correct and over-/underexposure indicated in viewfinder

## (Technical details)

**Built-in flash:** Autozoom, auto positioning, pre-flash for red-eye reduction (selectable); function as AF illuminator/self-timer indicator/Remote/Wireless off-camera flash control; guide number: 14 (lens 28mm) - 17 (lens 80mm) in meters at ISO 100, 46 (lens 28mm) - 56 (lens 80mm) in feet at ISO 100; approx. 2.5 sec. recycle time; slow-shutter sync. in P, S, and A modes with spot-metering button

**TTL flash metering:** Operates in all flash modes with built-in flash and dedicated units, in P, A, or S mode, pressing spot-metering button sets slower shutter speed (down to 30 sec.) to balance flash with ambient lighting

Programmed AE: Aperture and shutter speed set automatically; built-in and attached accessory flash fires automatically when necessary

Shutter-priority AE: Shutter speed and aperture set automatically; built-in and attached accessory flash will fire when activated

Aperture-priority AE: Any available aperture usable; shutter speed automatically set to 1/90 sec.; built-in and attached accessory flash will fire when activated

Manual: Any available shutter speed or aperture usable; built-in and attached accessory flash will fire when activated

**Exposure Compensation:** +/-4 stops in 1/2-stop increments

**Shutter:** Electronically-controlled, vertical-traverse, focal-plane type

**Auto stand-by zoom (ASZ):** Programmed selection of focal length based on subject distance; automatically activated by Eye-Start (only with xi-Series Autozoom lens)

**Image-size lock:** Continuous setting of focal length to maintain image size (only with an xi-Series lens)

**Film-speed setting:** Automatic setting for DX-coded films; ISO 100 set for non-DX-coded films; range: ISO 25-5000 in 1/3-stop increments

**Film transport:** Auto threading, auto advance to first frame, single frame advance or continuous (1fps) selectable; automatic or manual rewind start; frame counter in body data panel

**Viewfinder:** Eye-level fixed pentaprism showing 92% of vertical and 94% of horizontal field of view; magnification: 0.82X with 50mm lens at infinity; Acute-Matte screen

**Power:** 6-volt 2CR5 lithium battery; automatic battery check when camera is turned on; battery condition displayed by four-stage indicator in body data panel; shutter locks when battery is exhausted

**Self-timer:** Electronic with approx. 10-sec. delay of shutter release; cancelable; operation indicated by built-in flash

**Dimensions:** Standard model and QD model: 152.5 x 99 x 68.5mm (6 x 3-7/8 x 2-11/16 in.) (W x H x D)

**Weight:** 525g (18-1/2 oz.) (without battery) QD model: 540g (19 oz.) (without battery)

Specifications and accessories are based on the latest information available at the time of printing and are subject to change at any time without notice.

## GLOSSARY

This glossary is designed to help you get a basic understanding of some terms used in this instruction manual. The definitions are brief and simple and not intended to be complete and technical.

**angle of view:** A measure of how much of the scene will be recorded on the film as determined by the lens focal length and film format.

**aperture:** The adjustable opening in the lens that controls the amount of light passing through it to the film. The size of the lens opening is expressed by an f-number such as 5.6 or 16. Smaller f-numbers represent larger aperture openings and vice versa. For more information, refer to the Lens Aperture and Depth of Field section.

**depth of field:** The distance in front of and behind the point that the lens is focused on which will also be acceptably sharp. For more information, refer to the Lens Aperture and Depth of Field section.

**DX-coding:** The "checkerboard" pattern printed on film cartridges that encodes film speed and other information and can be read by most automatic cameras.

**exposure:** The total amount of light reaching the film as determined by shutter-speed and aperture settings.

**film speed:** The sensitivity of film, usually indicated by a number, e.g., ISO 100/21°. The first part of this corresponds to the former ASA number, the second to DIN. Together the numbers equal the international standard, ISO.

**f-number:** See aperture.

**focal length:** The distance from the film to the lens when the lens is focused at infinity. It plays a major role in determining how much of the scene will be recorded on the film. The focal length of a lens can be found printed on the lens barrel and expressed in millimeters. Telephoto lenses have longer focal lengths and wideangles, shorter.

**midtone:** Areas intermediate in lightness or brightness between highlights and shadows. Greys, as distinguished from whites and blacks.

**red-eye:** A condition in flash photography when the subject's eyes appear to glow pink or red. Red-eye is caused by light reflected from the retina into the lens.

**shutter:** The device in a camera that controls the time of exposure. This camera has focal-plane shutter which consists of two shutter curtains that move across the film from bottom to top, exposing the film to light from the lens.

**shutter speed:** The amount time that the film is exposed to light.

**SLR (single-lens reflex):** A type of camera that has a movable mirror behind the lens, and a viewfinder screen (or ground-glass) for viewing the image. Just before the shutter opens, the mirror moves out of the way to permit the image to fall upon the film. SLR cameras usually include a reflecting prism to produce an image rightside up oriented for viewing.

**stop:** The doubling or halving exposure to film. Each standard f-number (e.g., f/8) lets in twice as much light as the next larger one (f/11) and half as much as the next smaller one (f/5.6). This difference is called a change of one-stop. Each standard shutter speed (e.g., 1/60 sec.) allows light to strike the film twice as long as the next faster one (1/125) and half as long as the next slower (1/30). This change also called a one-stop difference.

**telephoto lens:** A long-focal-length lens, usually in the range of 70mm and longer. The angle of view and depth of field decreases as focal length increases.

**TTL meter:** A light meter that measures the intensity of light using a sensor cell located behind the lens of the camera.

**wideangle lens:** A short-focal-length lens, usually in the range of 35mm and shorter. Angle of view and depth of field increases as focal length decreases.

## QUICK REFERENCE GUIDE

If two operations are marked, do them at the same time.

The display shown should appear after you perform the indicated operation.

### When you want to...

**reset camera to standard, default settings**

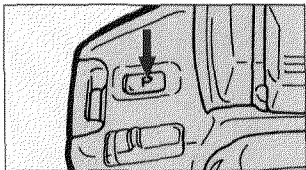

**change exposure mode**

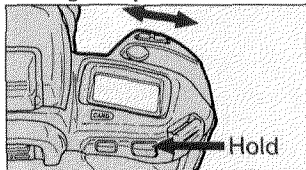

**set/cancel pre-flash**

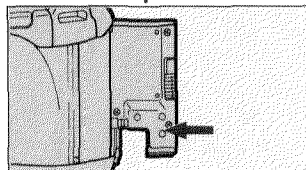

**manual fill-flash (in P mode)**

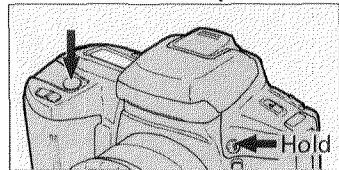



### cancel flash (in P mode)

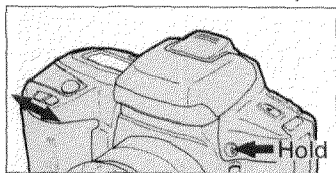

### set/cancel flash (in A, S, or M mode)

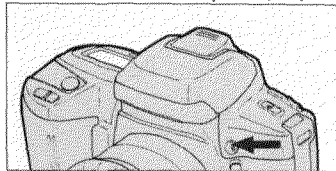

### set remote/wireless flash mode

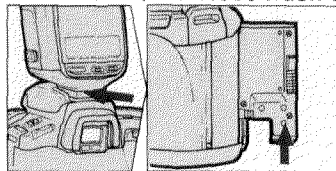

### test-fire (in remote/wireless mode)

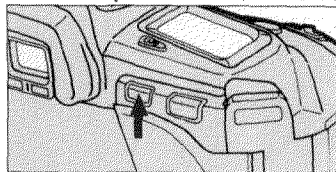

### cancel ASZ

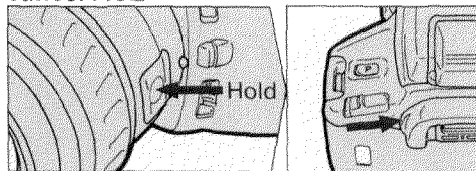

## power zoom (xi-Series lens)

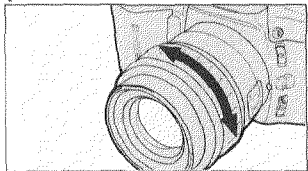

## lock focus

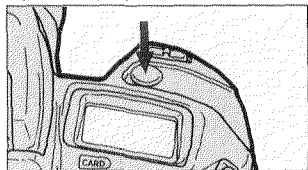

or

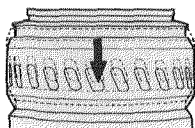

(xi-Series lens)

## power focus (xi-Series lens)

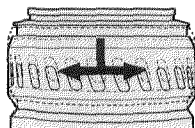
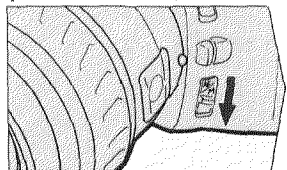

## manual focus

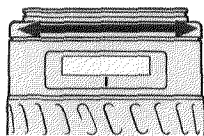
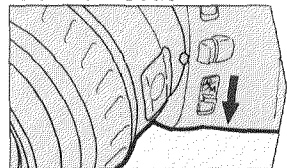

## set self-timer/drive mode

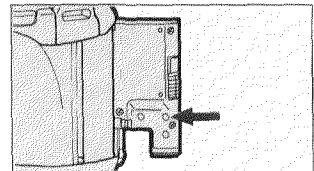

### cancel AF illuminator

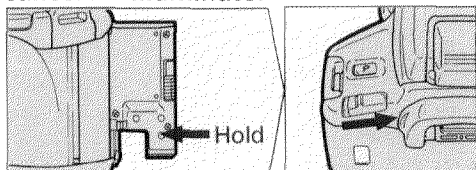

### battery check

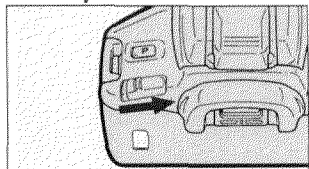

### manual rewind

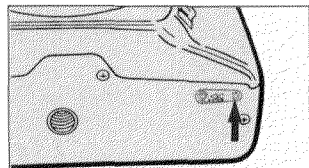

### image-size lock

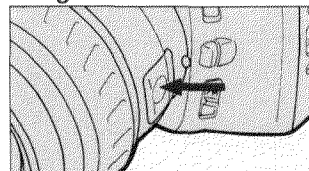

### set exposure compensation

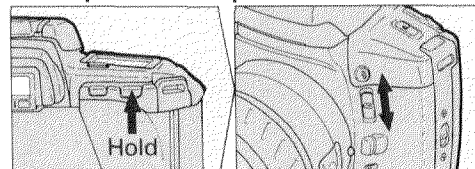



MINOLTA

<b>Minolta Camera Co., Ltd.</b>	<b>3-13, 2-Chome, Azuchi-Machi, Chuo-Ku, Osaka 541, Japan</b>
<b>Minolta GmbH</b>	Kurt-Fischer-Strasse 50, D-22923 Ahrensburg, Germany
<b>Minolta France S.A.</b>	365, Route de Saint-Germain, 78420 Carrieres-Sur-Seine, France
<b>Minolta (UK) Limited</b>	1-3 Tanners Drive, Blakelands North, Milton Keynes, MK14 5BU, England
<b>Minolta Austria Ges. m.b.H.</b>	Amalienstrasse 59-61, 1131 Wien, Austria
<b>Minolta Camera Benelux B.V.</b>	Zonnebaan 39, P.O. Box 1364 3600 Maarssebroek, The Netherlands
Belgium Branch	Kontichsesteenweg 38, B-2630 Aartselaar, Belgium
<b>Minolta (Schweiz) AG</b>	Riedstrasse 6 8953 Dietikon, Switzerland
<b>Minolta Svenska AB</b>	Brännkyrkagatan 64, Box 17074, S-10462 Stockholm 17, Sweden
Finland Branch	Niitykatu 6 PL 37 SF-02201 Espoo, Finland
<b>Minolta Portugal Limitada</b>	Av. do Brasil 33 a, 1700 Lisbon, Portugal
<b>Minolta Corporation</b>	
Head Office	101 Williams Drive, Ramsey, New Jersey 07446, U.S.A.
Los Angeles Branch	11150 Hope Street Cypress, CA 90630, U.S.A.
<b>Minolta Canada Inc.</b>	
Head Office	369 Britannia Road East, Mississauga, Ontario L4Z 2H5, Canada
Vancouver Branch	106-3850 Jacombs Road, Richmond, B.C. V6V 1Y6, Canada
<b>Minolta Hong Kong Limited</b>	Room 208, 2/F, Eastern Center, 1065 King's Road, Quarry Bay, Hong Kong
<b>Minolta Singapore (Pte) Ltd.</b>	10, Teban Gardens Crescent, Singapore 2260

© 1992 Minolta Camera Co., Ltd. under the Berne  
Convention and Universal Copyright Convention