

MINOLTA

MAXXUM[®]
DYNAX[™]

2xi



E INSTRUCTION MANUAL

READ ME FIRST!

First of all, thank you for purchasing this Maxxum/Dynax 2xi. Also, if this is your first Minolta camera, welcome to the Minolta family.

This instruction manual has been designed to help you get the most enjoyment and use out of your new camera. It is not necessary for you to read the contents of this manual from cover-to-cover before you begin taking pictures. Instead, it is better that you read it in sections.

Begin by learning a little about the manual itself by reading the **TABLE OF CONTENTS** on p.2. This will give you an idea of kinds of information included in the manual and the way in which it is organized. Next, pick up your camera and, using **NAMES OF PARTS AND DISPLAYS**, become familiar with the layout of its controls and indications. Continue to the next section, **PREPARATIONS**, and follow along with your own camera by attaching the neckstrap and a lens, inserting a battery, ect. When you are finished, read **SIMPLE OPERATION — THE BASICS** thoroughly and you should be ready to begin using your new camera. When you want to take more creative control over your photography, **OPERATIONS IN DETAIL** will help you do so. Finally, **APPENDIX** contains information about the camera and general photography, which may be helpful to you in the near future. Refer to it as you need.

A note about the indicators which appear in this manual: a display surrounded by star-burst rays such as  or  means that the indicator is blinking.

You are probably anxious to begin, so good luck and we hope that this camera will help you to discover and enjoy the many pleasures of the world of photography.

IMPORTANT INFORMATION

The Minolta Maxxum/Dynax 2xi was designed to work specifically with lenses, flash units, and other accessories manufactured and distributed by Minolta. We therefore caution users of this camera that the attachment and/or use of incompatible products with the 2xi may result in unsatisfactory performance or damage to the camera or its accessories. To obtain optimum performance throughout the life of your Maxxum/Dynax 2xi, we recommend that you use only those lenses, flashes and other accessories distributed by Minolta specifically for use with this camera.

STATEMENT OF FCC COMPLIANCE

This device complies with Part 15 of the FCC Rules. Operation is subject to the following two conditions: (1) This device may not cause harmful interference, and (2) this device must accept any interference received, including interference that may cause undesired operation. Changes or modifications not approved by the party responsible for compliance could void the user's authority to operate the equipment. This equipment has been tested and found to comply with the limits for a Class B digital device, pursuant to Part 15 of the FCC Rules. These limits are designed to provide reasonable protection against harmful interference in a residential installation. This equipment generates, uses and can radiate radio frequency energy and, if not installed and used in accordance with the instructions, may cause harmful interference to radio communications. However, there is no guarantee that interference will not occur in a particular installation. If this equipment does cause harmful interference to radio or television reception, which can be determined by turning the equipment off and on, the user is encouraged to try to correct the interference by one or more of the following measures:

Reorient or relocated the receiving antenna.

Increase the separation between the equipment and receiver.

Connect the equipment into an outlet on a circuit different from that to which the receiver is connected. Consult the dealer or an experienced radio/TV technician for help.

STATEMENT OF DOC COMPLIANCE

This digital apparatus does not exceed the Class B limits for radio noise emissions from digital apparatus as set out in the Radio Interference Regulations of the Canadian Department of Communications.

TABLE OF CONTENTS

Names of Parts and Displays	Body	4
	Data panel	6
	Viewfinder	7

PREPARATIONS

Preliminary	Neckstrap	9
	Eyepiece and accessory shoe cap	9
Lens	Attaching	10
	Removing	11
	Care of glass surfaces	11

SIMPLE OPERATION

Holding the Camera	20
Taking Pictures	21
	Focus signals	22

OPERATIONS IN DETAIL

Focusing Details	Special focusing situations	26
	Manual focus	27
Exposure Details	Spot metering	28
	Exposure modes	30
	Changing exposure modes	30
	A: Aperture priority	31
	S: Shutter priority	32
	M: Manual exposure	33
	Exposure warnings and signals	34
	Bulb: Long exposures	35

APPENDIX

Lens Aperture and Depth of Field	39
Shutter Speed and Moving Subjects	41
Care and Storage	42

Battery	Inserting	12
	Battery-condition indicators	13
	Battery performance	14
	Cold-weather operation	14
Film	Automatic film-speed setting	15
	Loading film	15
	Automatic rewind	18
	Manual start of rewind	18
<hr/>		
Focus Lock		23
Self-Timer		24
<hr/>		
Flash Details	Flash in P mode	36
	Flash in A, S, and M modes	37
	Slow-shutter sync	37
<hr/>		
Accessory Information		44
Technical Details		45

NAMES OF PARTS AND DISPLAYS

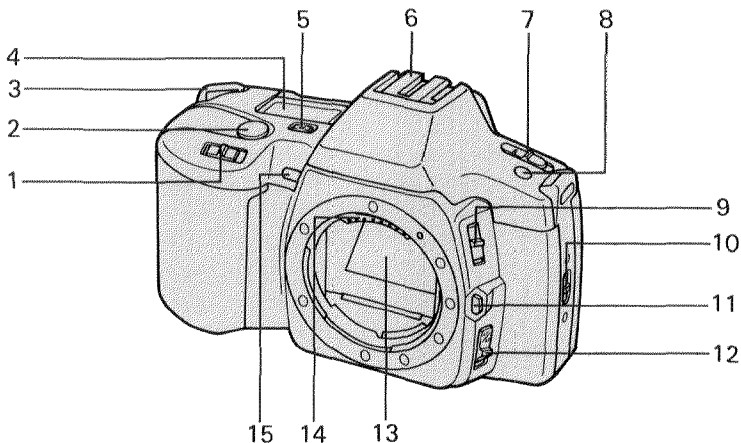

1. Shutter-setting control
(pp.30, 32, 33)
2. Shutter-release button
Pressing this button partway down activates autofocus and autoexposure. Also locks focus on a stationary subject (p.23).
Pressing all the way down takes a picture.
3. Strap eyelet
4. Data panel (p.6)
5. Program re-set button
Re-sets camera to autofocus and programmed (P) autoexposure modes.
6. Accessory shoe
7. Main switch
8. Self-timer button (p.24)
9. Aperture-setting control
(pp.31, 33)
10. Back-cover release (p.16)
11. Lens release (p.11)
12. Focus-mode switch (p.27)
13. Mirror*
14. Lens contacts*
15. Self-timer light (p.24)

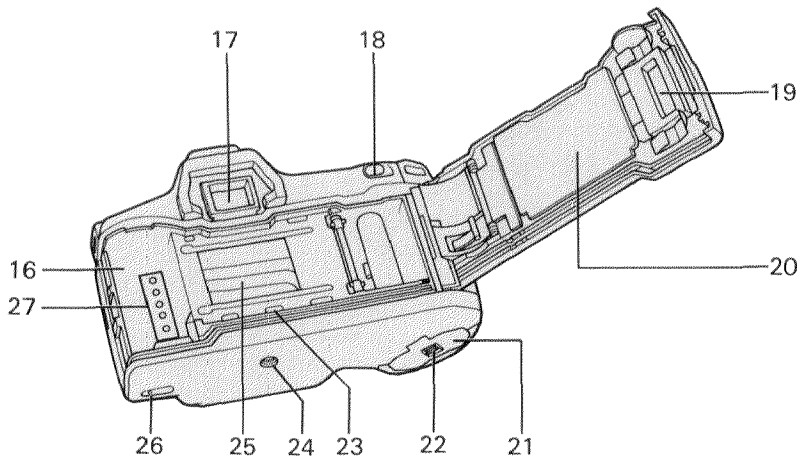

- | | |
|--------------------------------------|---------------------------|
| 16. Film chamber | 22. Battery-cover release |
| 17. Viewfinder eyepiece* | 23. Guide rails |
| 18. Spot-metering button (pp.28, 37) | 24. Tripod socket |
| 19. Film window | 25. Shutter* |
| 20. Pressure plate* | 26. Rewind button (p.18) |
| 21. Battery cover | 27. DX contacts* |

*Do not touch

(Names of parts and displays)

Data Panel

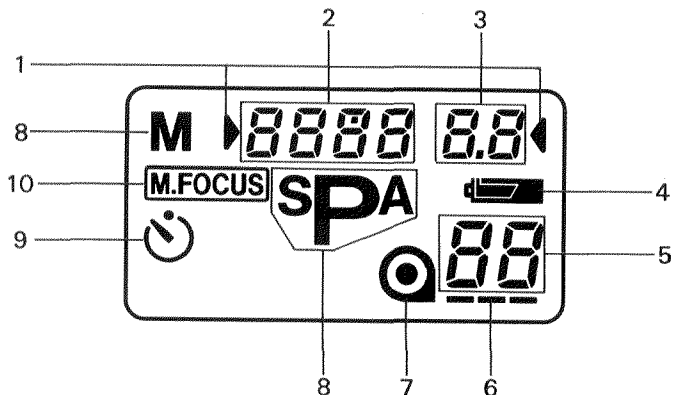

1. Selectable setting pointers
Indicates which settings are under manual control
2. Shutter-speed display
Displays current shutter speed setting
3. Aperture display
Displays current aperture setting
4. Battery-condition indicator (p.13)
5. Frame counter
Displays current frame number
6. Film-transport signals
7. Film cartridge mark (pp.15, 18)
8. Exposure-mode indicators (p.30)
9. Self-timer indicator (p.24)
10. Manual-focus indicator (p.27)

Viewfinder

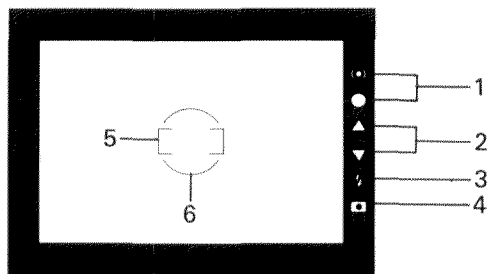

1. Focus signals (p.22)
2. Exposure signals (p.33, 34, 36)
3. Flash signal (p.36)
4. Spot-metering indicator (p.29)
5. Focus frame (p.21)
6. Spot-metering area (p.28)

PREPARATIONS

This section includes those things which you should do and understand before you use your camera. Read it thoroughly before you go on to **SIMPLE OPERATION** or **OPERATIONS IN DETAIL**.

PRELIMINARY

Neckstrap

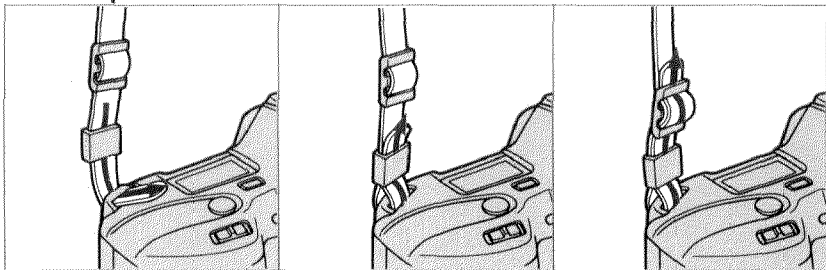

A neckstrap is supplied with your camera. Attach it as shown above.

Eyepiece and Accessory Shoe Cap

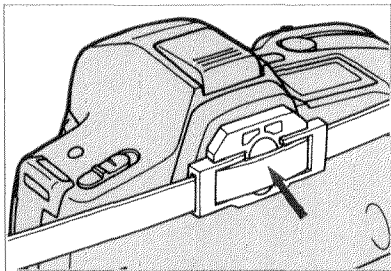

An eyepiece cap is attached to the strap. Fasten it to the viewfinder eyepiece whenever you use the self-timer or make long exposures. To attach the cap, snap it in place over the eyepiece as shown above; pull to remove.

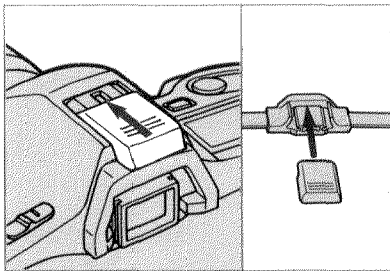

The camera also comes with an accessory shoe cap which protects the accessory-shoe contacts. When you are using a flash or other accessory, slide the accessory shoe cap into the eyepiece cap for safekeeping.

LENS

Attaching

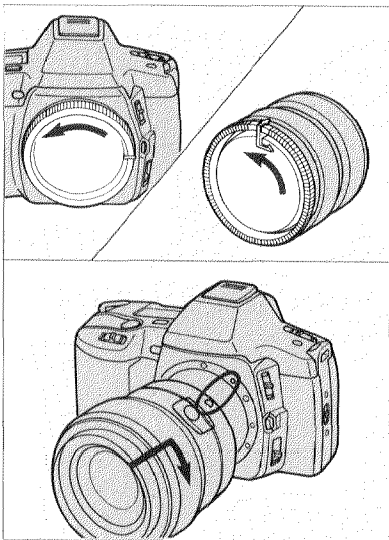

1. Turn the body cap and lens cap as shown and remove them.

2. Align the red bead on the lens barrel with the red dot on the camera's lens mount. Fit the lens into the mount and turn the lens clockwise until it locks in place with a click.

Be careful...

- Do not force the lens if it does not turn smoothly.
- Never touch anything inside the camera, especially the lens contacts and mirror.

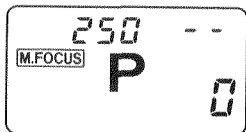

"--" will appear in the aperture display of the data panel when you press the shutter-release button partway down if:

- No lens is attached to the camera
- The lens is not attached properly
- The AZ/MZ switch on an xi-Series lens is set to MZ

Removing

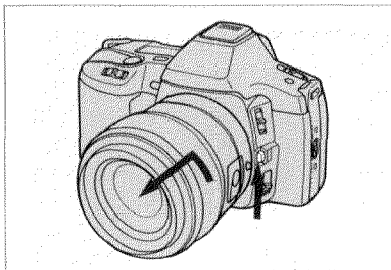

1. Press the lens release and hold it in while you turn the lens counter-clockwise until it stops. Lift the lens out of the mount.

2. Immediately attach the rear cap to the lens and the body cap or another lens to the camera. This will protect the lens elements, lens contacts, and camera interior.

Care of Glass Surfaces

- Never touch any lens surfaces (including the eyepiece) with your fingers. If a lens becomes dirty, first gently clean it with a lens brush. Then, if necessary, moisten a sheet of lens tissue with one drop of lens-cleaning fluid and, starting from the center of the lens, wipe the glass using a circular motion.
- Never lift the mirror or touch its surface. This may impair its alignment or scratch its face. Dust on the mirror's surface will not affect meter readings or picture quality. If it is distracting, have the camera cleaned at an authorized Minolta service facility.

BATTERY

This camera uses a 6-volt 2CR5 lithium battery to supply power to all of its operations. If you are also using an xi-Series lens, the camera battery also supplies power to the zoom motor built into the lens.

Inserting

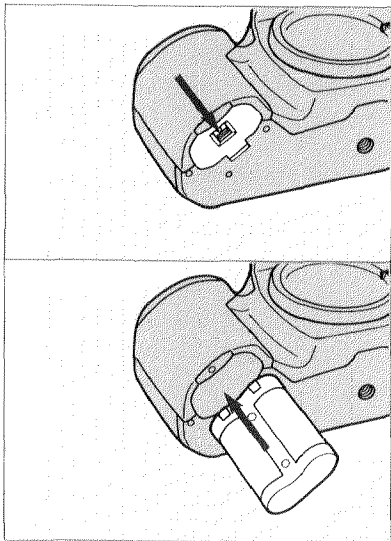

1. Move the main switch to **LOCK** and slide the battery cover release in the direction indicated to open the battery cover.

2. Insert the battery according to the marks on the inside of the chamber cover.



3. Snap the cover closed.

CAUTION

- Read and follow all warnings and instructions supplied by the battery manufacturer.
- Do not attempt to disassemble, recharge, or short-circuit the battery. Do not subject it to high temperatures or fire. The battery may explode and cause severe burns.
- Keep batteries away from small children.

Battery-condition Indicators

Whenever you move the main switch from **LOCK** to **ON**, one of the following indicators will appear in the data panel.

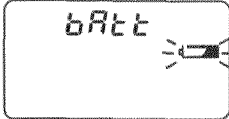
Indicator	Meaning
	1. Full-battery symbol appears for 4 sec. after you turn camera on—power is sufficient.
	2. Low-battery symbol appears for 4 sec. after you turn camera on—power is sufficient, but getting low. Keep a fresh battery handy.
	3. Low-battery symbol blinks while it appears with other operating indicators at any time during use—camera can be operated, but power is extremely low. The battery will need to be changed soon.
	4. Blinking low-battery symbol and bAtte appears, or no display appears at all, and shutter locks—power is insufficient for operation. Replace the battery or check that the battery is inserted correctly.

- Indicator 4 will appear even while the main switch is set to **LOCK**.

(Battery)

Battery Performance

The 6-volt 2CR5 lithium battery should provide sufficient power for shooting up to 60 rolls of 24-exposure film without flash. These figures are based on Minolta's standard test method using a fresh battery at 68°F (20°C). Actual performance will depend on how you use the camera. If you install a new battery that has been in prolonged storage, the camera's performance may vary.

Cold-Weather Operation

Lithium batteries perform well in cold weather. However, if you plan to shoot many rolls of film outdoors at temperatures near or below 32°F (0°C), we recommend that you carry the camera inside your coat to keep it warm while you are not shooting. You may also want to carry a spare battery in your pocket so that you can change the camera battery if necessary. Do not discard a cold battery. After it warms up, it will regain some of its charge.

FILM

Automatic Film Speed Setting

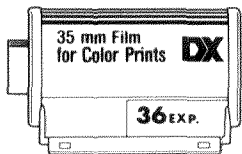

If you use DX-coded film between ISO 25 and 5000, the camera will automatically set the correct film speed when you insert the cartridge. For flash photography, Minolta recommends that you use film between ISO 25 and 1000. If you use non-DX-coded film, the camera will automatically set ISO 100.

Loading Film

Before you load a roll of film, always check the data panel. If the film cartridge is displayed, **do not open the back cover**. Check the film window and frame counter to verify the type of film in the camera and the number of frames remaining. (See p.18 for instructions on rewinding an unfinished roll of film.)

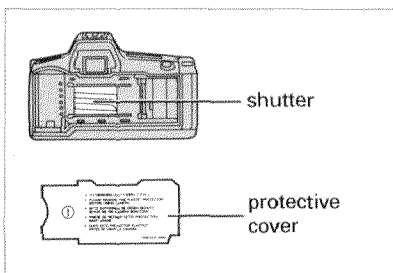

- Always load film in subdued light or shade.
- Before you load film for the first time, carefully remove and discard the protective plastic cover over the shutter.

— NEXT PAGE —

(Film)

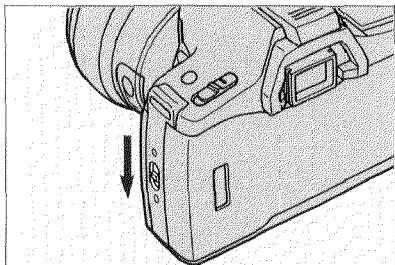

1. Open the back cover by sliding the back-cover release downward.

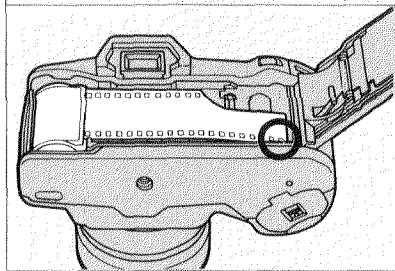

2. Place the film cartridge into the film chamber and extend the leader between the guide rails until the tip is just past the film-leader index.

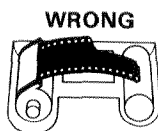
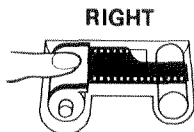

● **NEVER TOUCH THE SHUTTER CURTAIN WITH YOUR FINGERS OR WITH THE FILM TIP.** Its precision design makes it extremely sensitive to pressure.

● If the film leader is torn or crimped, it may not wind properly.

● If the film tip extends beyond the mark, gently push the excess back into the cartridge.

— NEXT PAGE —

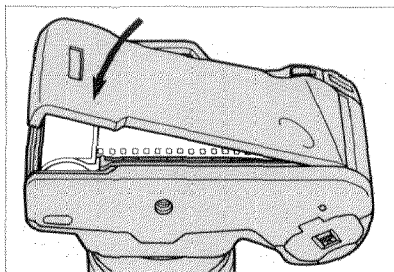

3. Close the back cover and move the main switch to **ON**. The camera will automatically advance the film to the first frame and **1** will appear in the film counter.

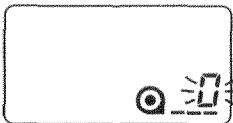

• If the film is loaded incorrectly, **0** will blink in the frame counter and the shutter will remain locked. Open the back cover and repeat steps 2 and 3.

• If you accidentally open the back cover before you rewind the film, quickly shut the back. The counter will reset to **1**. Some of the pictures you have already taken will be ruined or will be discolored along the edges.

(Film)

Automatic Rewind

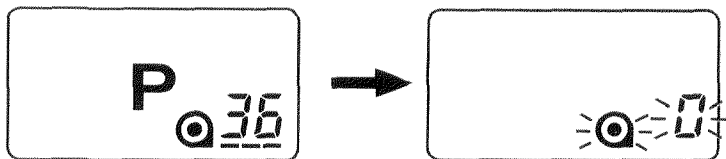

After you have exposed the last frame, the camera will automatically rewind the film. With a fresh battery, it takes about 18 sec. to rewind a 36-exposure roll, or 12 sec. for a 24-exposure roll.

When the film has been completely rewound, the motor will stop and the film-cartridge mark in the data panel will blink to indicate that it is safe to open the back cover.

Manual Start of Rewind

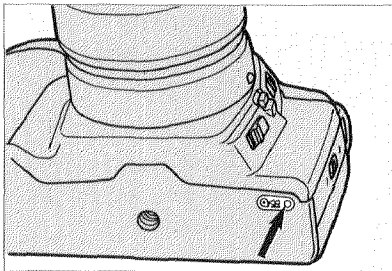

To begin rewind at any time, gently press the film rewind button on the bottom of the camera body.

- If the motor stops before the film is completely rewound, insert a fresh battery.

SIMPLE OPERATION — THE BASICS

This brief section is intended to help you get started using your new camera. It explains the simplest method of operation—with programmed autoexposure and autofocus. Details on each of the camera's functions begins on p.25 in the section entitled "Operation in Detail".



HOLDING THE CAMERA

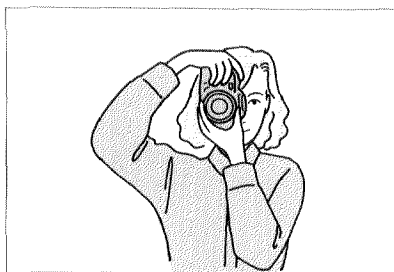
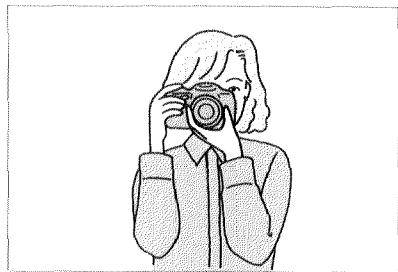

Hold the grip firmly in your right hand and use your left hand to support the camera body or lens barrel. Keep your elbows securely against your sides when shooting both horizontal and vertical pictures. Press the shutter-release button gently in a single, steady motion—never with a quick jab. Always keep the camera strap around your neck or wound around one wrist.

- Do not touch the focusing ring of an AF lens or the end of the lens barrel of an xi-Series Autozoom lens or AF Power Zoom lens while autofocus is operating.

TAKING PICTURES

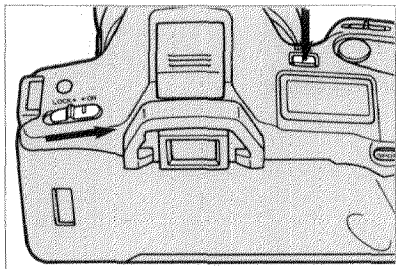

1. Slide the main switch to **ON** and press the program-reset button.

● Pressing the program-reset button sets the camera to programmed autoexposure (P) mode and autofocus. Also, if a flash is attached this sets auto switchover flash (see flash manual for details).

2. Hold the camera as described on p. 20.

3. Place your main subject in the focus frame and press the shutter-release button partway down to activate autofocus and autoexposure.

4. When either the continuous autofocus (●) or focus lock indicator ● appears in the viewfinder (see next page), press the shutter-release button all the way down to take the picture.

After the picture has been taken, the camera will automatically advance the film to the next frame and will increase the film counter by one.

(Taking Pictures)

Focus Signals

One of the following focus signals will appear in the viewfinder when you press the shutter-release button partway down.

Signal	Meaning
(●)	Continuous autofocus*
●	Focus is locked (stationary subject)
➤●➤ (blinking)	Focus cannot be confirmed (see p.26)

* This appears when continuous autofocus is functioning (when subject is moving) and before focus is locked (when subject is stationary).

- When ▼ blinks in the viewfinder and an accessory flash is not attached, the required shutter speed is too slow to allow sharp photography without a tripod or other camera support. You should either use a flash or attach the camera to a tripod.
- This camera has Predictive AF. When you take a picture of a moving subject, the camera will calculate where the main subject will be when the shutter curtain actually begins to make the exposure. It will then set the lens to focus on this point before the mirror swings up. Extremely fast-moving subjects or subjects which are rapidly changing speed or direction, however, may exceed the capabilities of this system.

FOCUS LOCK



If, as a result of the composition or framing you have chosen, the main subject falls outside the main focus frame, first lock focus on your subject, then recompose the scene as desired.

1. Place your subject in the center of the AF area.

2. Press the shutter-release button partway down and wait until the focus lock signal ● appears in the viewfinder.

3. Continue holding the shutter-release button partway down, recompose the picture, and press the shutter-release button all the way down to take the picture.

● Focus lock will not function if your subject is moving.



Focus lock with the lens control ring:

If you are using an xi-Series or power zoom lens, you can lock focus by pulling the lens control ring towards the camera. Hold it in this position while you recompose and take the picture. Do not turn the ring after you lock focus.

SELF-TIMER

The electronic self-timer will delay release of the shutter by about 10 sec. from the time you press the shutter-release button.

To activate the self-timer:

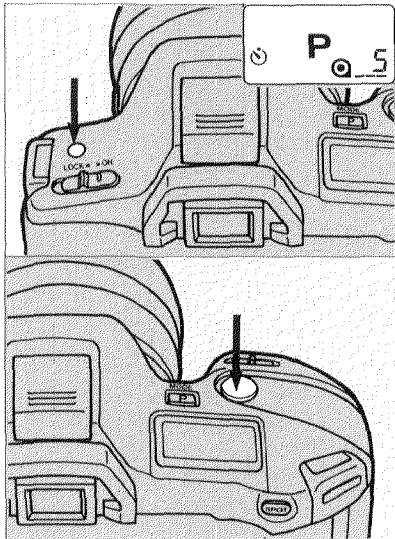

1. Press the self-timer button. The self-timer indicator will appear in the data panel.

- Press the self-timer button again to cancel.

2. Compose your scene and press the shutter-release button partway down to activate autofocus.

3. When focus lock signal ● appears in the viewfinder, attach the eyepiece cap and press the shutter-release button all the way down to begin the countdown.

- The self-timer light will blink while the self-timer is counting down.
- To cancel the self-timer while it is operating, move the main switch to **LOCK**.
- The self-timer automatically switches off after shutter-release. To make another exposure with the self-timer, repeat steps 1-3.

OPERATIONS IN DETAIL

Once you have learned the basics of using your camera, this section will help you to take more control over its operation.

FOCUSING DETAILS

Special Focusing Situations

The camera's autofocus system will produce sharp pictures in almost every situation. In the cases described below, however, it may be difficult or impossible for the camera to autofocus properly—you may have to use focus lock (p.23) or manual focus (next page).

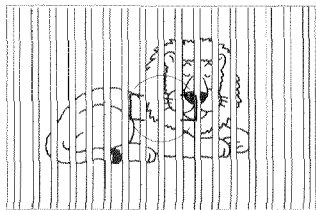

When two subjects at different distances overlap within the focusing frame

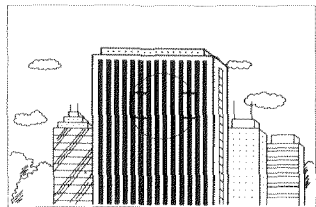

On a subject composed of alternating light and dark lines completely fills the focusing frame

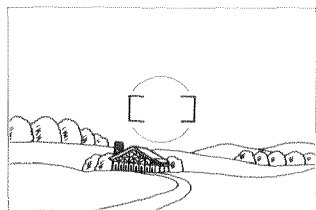

On very bright or low-contrast subjects

Manual Focus

To manually focus the lens:

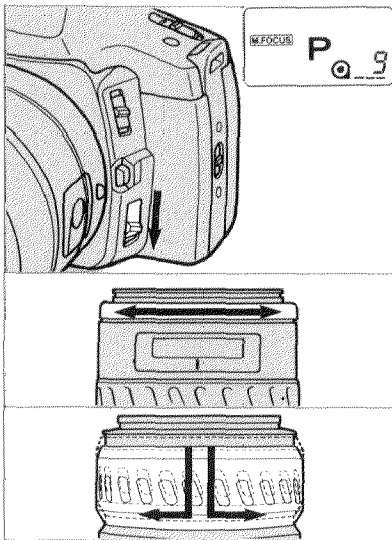

1. Slide the focus-mode switch down to set the camera to manual focus mode.

M. FOCUS will appear in the data panel.

2. If you are using an AF lens, turn the focusing ring until the subject appears sharp. With an xi-Series lens or AF power zoom lens, pull and turn the control ring. For more information, refer to the lens manual.

- When your subject comes into focus, the focus lock signal ● will light in the viewfinder.
- To return to autofocus mode, slide the focus-mode switch down.
- Pressing the program re-set button will also return the camera to autofocus mode, and will also change all of the programmable functions to their default settings.
- In manual focus mode, the shutter will release even if the subject is not in focus.

EXPOSURE DETAILS

Spot Metering

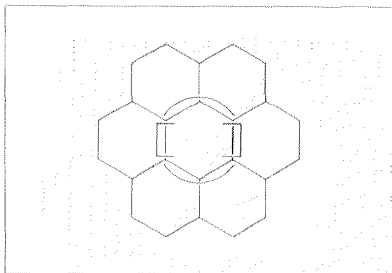

8-segment
honeycomb-pattern metering

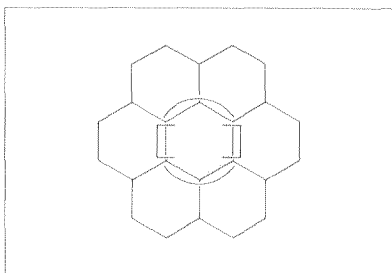

Spot metering

The camera's normal metering mode is 8-segment honeycomb-pattern metering, which evaluates eight separate areas of the scene in the viewfinder to arrive at a shutter speed and aperture. If your scene is extremely contrasty or if you are using a reference subject for metering, spot metering will help you obtain consistent, precise exposure readings of the spot-metering area. When spot metering is active, the camera uses only the center segment of the honeycomb-pattern metering cell to read the subject brightness.

To use spot metering:

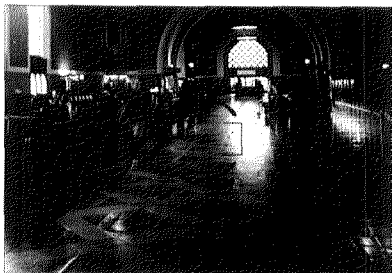

1. Center the spot-metering area over the subject you want to meter.

— NEXT PAGE —

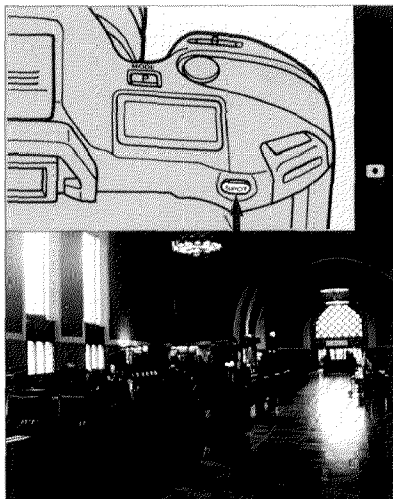

2. Press and hold the spot-metering button.

● The spot-metering indicator  will appear in the viewfinder.

3. Continue to hold the spot-metering button and recompose your scene as desired.

4. Press the shutter-release button all the way down to take the picture.

- Be sure you spot meter an area which will appear as a middle grey or average brightness in your final picture.
- When you are using flash, you cannot use spot metering. In P, A, or S modes with the flash on, pressing the spot-metering button activates slow-shutter sync (see p. 37).

(Exposure Details)

Exposure Modes

The camera has four exposure modes: programmed autoexposure (P), aperture-priority autoexposure (A), shutter-priority autoexposure (S), and manual exposure (M). In P mode, Expert Program Selection automatically sets the optimum shutter speed and aperture based on such factors as subject distance, brightness, and movement as well as focal length before it sets an aperture and shutter speed. The other three modes provide varying degrees of creative and operational flexibility and are explained in following sections.

Changing Exposure Modes

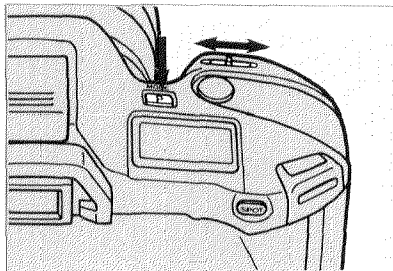

1. Press and hold the program re-set button and move the shutter-setting control.
2. Release the program re-set button to enter the mode you have chosen.

- To return to P mode, press the program re-set button.

A: Aperture-Priority

In A mode, you set the aperture you want and, the camera will automatically set the correct shutter speed.

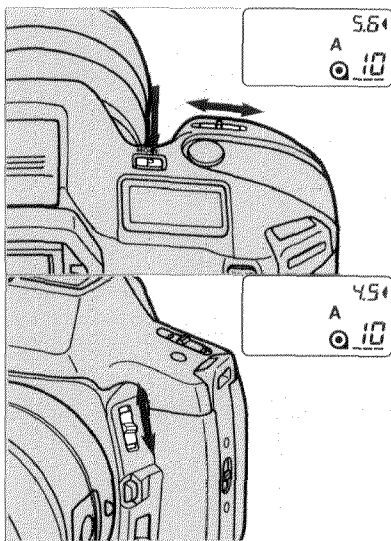

1. Refer to p.30 (Changing Exposure Modes) and select **A**. A pointer will appear next to the aperture display.

2. To set the aperture, slide the aperture-setting control up or down. The aperture display in the data panel will change in 1/2-stop increments.

- Available apertures are limited to those within the range indicated on the lens you are using.
- When ▼ blinks in the viewfinder and an accessory flash is not attached, the required shutter speed is too slow to allow sharp photography without a tripod or other camera support. You should either set a larger aperture, use a flash, or attach the camera to a tripod.

(Exposure Details)

S: Shutter-Priority

In S mode, you select the shutter speed you want and, if the lens you are using allows, the camera will automatically set the correct aperture to ensure a proper exposure.

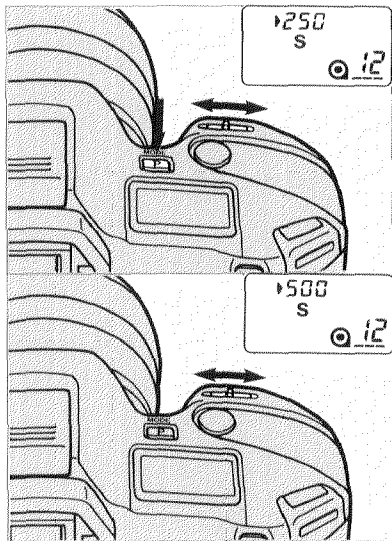

1. Refer to p.30 (Changing Exposure Modes) and select **S**. A pointer will appear next to the shutter speed displays.

2. To set the shutter speed, move the shutter-setting control to the left or right. The shutter speed display in the data panel will change in 1-stop increments.

- You cannot use BULB in **S** mode (see p.35).

M: Manual Exposure

In manual mode, you select the shutter speed and aperture and the camera will indicate whether your settings will provide an over-, under-, or correctly-exposed picture.

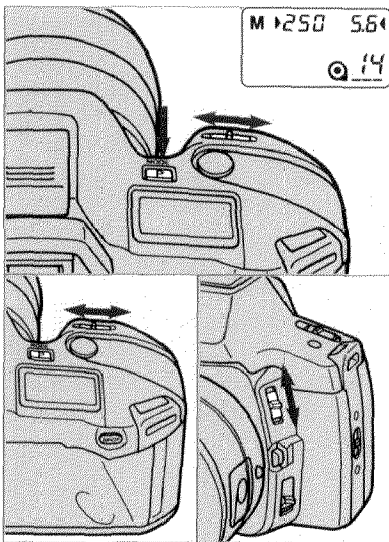

1. Refer to p.30 (Changing Exposure Modes) and select **M**. Pointers will appear next to both the shutter speed and aperture displays.

2. To set the shutter speed, move the shutter-setting control to the right or left. To set the aperture, move the aperture-setting control up or down.

The shutter speed will change in 1-stop increments and the aperture will change in half-stop increments.

Viewfinder Exposure Signals in M Mode



In M mode, the following indicators will help you set a correct exposure.

Viewfinder signal	Meaning
◆	Correct exposure
▲	Over exposure
▼	Under exposure

(Exposure Details)

Exposure Warnings and Signals

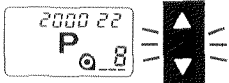
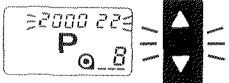
One of the following warnings will appear when the camera's autoexposure system has difficulty measuring the light level or in setting the proper shutter speed and/or aperture. Blue marks around a display indicate that it is blinking.

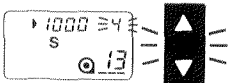
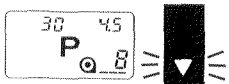
	Display	Cause	Action
P/A S/M		The light level is beyond the camera's metering range.	In low light, use faster film or increase the brightness of your surroundings. In bright light, attach a filter, use slower film or reduce the overall brightness of your surroundings.
P		Light level is beyond the range of available shutter speeds and apertures.	
A		The required shutter speed is beyond the camera's range	Move the aperture-setting control until the display stops blinking.
S		The required aperture is beyond the range of the lens in use.	Move the shutter-setting control until the display stops blinking.
P/A		The required shutter speed is too slow. Blurred pictures may result.	Increase the light level, use a flash, attach the camera to a tripod, or, in A mode, set a larger aperture.

BULB: Long Exposures

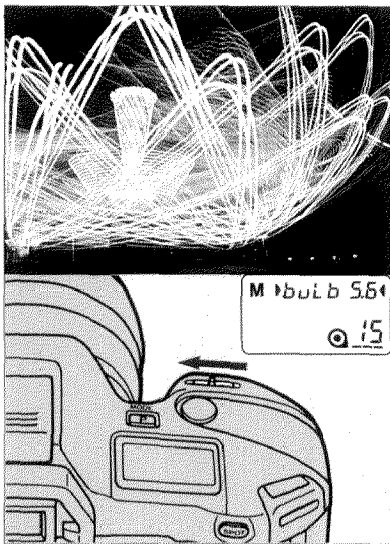

When you select **BULB**, the shutter will remain open as long as you hold the shutter-release button down so that you control the length of the exposure. This setting can only be made in manual exposure mode.

To use BULB:

1. Mount the camera on a tripod and select manual exposure (**M**) mode.

2. Slide the shutter-setting control to the left until **bulb** appears in the data panel. Use the aperture setting control to select the aperture you want.

3. Compose your scene and focus the lens.

• If the scene is too dark, autofocus may not function. Slide the focus mode switch down and focus the lens manually (see p.27).



4. Attach the eyepiece cap to prevent stray light from entering the camera and affecting the exposure (see p.9).

5. Press the shutter-release button and hold it down for the duration of the exposure.

FLASH DETAILS

Flash in P mode

In P mode, when you attach an accessory flash to the 2xi and turn the flash on, it will fire whenever necessary. The following signals will appear in the viewfinder to inform you of the flash's operation:

Viewfinder Signal	Meaning
 blinking	Flash charging
 blinking slowly	Flash charged
 blinking rapidly	Flash output sufficient*

* This signal appears after you take the picture when the light supplied by the flash was enough to provide a correct exposure.

- In P mode, if you turn the flash off, it will not fire.
- If you turn off an accessory flash and the shutter speed is too slow to allow sharp pictures while hand-holding the camera, the camera-shake warning () will blink in the viewfinder. Mount the camera on a tripod or turn the flash on. In S or M mode, the camera-shake warning will not function.

Flash in A, S, and M Modes

In A, S, and M modes, when an attached accessory flash is activated, it will fire every time you take a picture. When it is off, it will not fire.

- Flash signals in A, S, and M modes will be the same as those in P mode.

Exposure mode	Available shutter speeds when flash activated
A	1/90 sec. (set automatically)
S	1/90 - 30 sec. (set automatically)
M	1/90 - 30 sec. and BULB (set manually)

Slow-Shutter Sync

The slow-shutter sync option will set a slower shutter speed to increase the background exposure in a flash picture. Flash output will be controlled automatically to maintain a correct exposure of your subject.



1. Frame your subject in the focus frame.
2. Press and hold the spot-metering button.
3. Continue to hold the spot-metering button and press the shutter-release button down completely to take the picture.

- If the background is bright or a large aperture is set, the shutter speed may not be reduced.
- The flash signal in the viewfinder will blink rapidly if the flash output was sufficient to provide a correct exposure.

APPENDIX

(Lens Aperture and Depth of Field)



Large aperture



Small aperture

For example, in a portrait situation, you may want to use a larger aperture in order to focus only on the main subject and separate the person from their background. A small aperture, on the other hand, would be preferable in such cases as landscape photography when you want as much of the scene as possible to appear in focus. Expert Program Selection will automatically set a large aperture in portrait situations so that only your main subject will appear in sharp focus, and a small aperture for landscapes and extreme close-ups to maximize depth of field.

For any given f-number and subject distance, an increase in focal length will reduce the depth of field and a decrease in focal length will have the opposite effect. For example, if a 28-105mm zoom lens is set at 50mm, f/8 and the subject is 12 ft. (4m) away, changing the focal length to 90mm without altering the exposure settings or subject-to-camera distance will noticeably shorten the depth of field. Setting the lens to 28mm, however, extends the range which will appear in focus.

Depth of field also depends on subject distance. Without changing lens aperture or focal length in the above case, if you move to 6 ft. (2m) from your subject, there will be less depth of field in the final image.

SHUTTER SPEED AND MOVING SUBJECTS

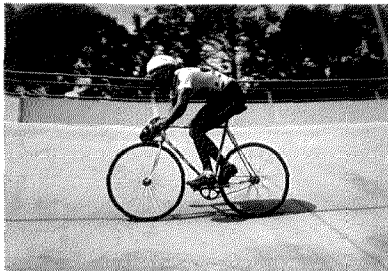

Fast shutter speed



Slow shutter speed

Your choice of shutter speed is an important factor in determining how moving subjects will appear in the final image. Depending on the speed of your subject, slower shutter speeds such as $1/15$ sec. will make moving subjects appear blurred and flowing in the picture, creating a greater feeling of motion. Fast shutter speeds, of course, are useful to freeze fast action.

Also, if you are using a telephoto lens, a fast shutter speed can help prevent blurring caused by camera shake. For lenses longer than $f' = 50\text{mm}$, a general rule to follow is that $1/f'$ is the slowest usable shutter speed while the camera is being hand-held. For example, if you are using a 135mm lens, try to avoid using shutter speeds slower than $1/180$ sec. (the closest shutter speed to $1/135$) if you are not using a tripod.

CARE AND STORAGE

- Always keep your camera in its case with the lens capped when not in use, or with a body cap on when a lens is not attached.
- No part of the camera should be forced at any time.
- 72-exposure cartridge and polaroid instant 35mm films cannot be used.
- Never subject your camera to shock, high heat, humidity, water, or harmful chemicals. Be particularly careful not to leave it in the glove compartment or other places in motor vehicles where it may be subjected to high temperatures.
- Never lubricate any part of the camera body or lens.
- Never touch the shutter curtains, mirror, or the interior of the body or clean them with compressed air. Doing so may impair their alignment and movement.
- External camera surfaces and lens barrel—but not glass surfaces—can be cleaned by wiping with a dry or silicone-treated cloth. Never use organic solvents to clean the camera.
- Never touch the lens or eyepiece surfaces with your fingers. Whisk away loose matter with a blower brush. To remove stubborn spots, use a sheet of photographic lens tissue. If necessary, tissue may be moistened with one drop of lens-cleaning fluid; never place fluid directly on glass surfaces.
- We recommend that you have your camera cleaned once a year at an authorized Minolta service facility.
- If you plan to store your camera for an extended period of time, rewind and remove the film, then remove the battery. Place the camera in a cool, dry place away from dust or chemicals, preferable in an airtight container with a drying agent such as silica gel. Also, it is recommended that you periodically release the camera's shutter to maintain proper working condition.

- This camera is not waterproof, dustproof or sand-proof. If you use this camera near water or at the beach, water-, dust-, or sand-damage may occur. Protect it at all time from moisture or splashes, especially saltwater spray, and be extremely careful to keep sand from both the interior and exterior of the camera and its accessories. If it comes in contact with water, wipe it with a clean, dry cloth and bring it to an authorized Minolta Service facility. If it comes in contact with sand or if sand enters the camera, gently blow away loose particles —**wiping may scratch the camera**— and bring it to an authorized Minolta Service facility.
- If the camera is subjected to a sudden change in temperature, as when transferring it from a cold environment into a heated building, condensation may form inside. To prevent condensation, place the camera in a sealed plastic bag before transferring it from a cold place to a warm environment, and wait for it to come to room temperature before taking it out of the bag.
- After prolonged storage, and especially before taking pictures at an important event, carefully check the operation of the camera and lens.
- The operating range for camera's data panel is from -4 to 122°F (-20 to 50°C). At temperatures outside this range, response time and contrast will change, making the display difficult to read. At very high temperatures, the display may temporarily darken. If this occurs, the display should return when the camera is restored to operating range conditions.
- This camera contains no user-serviceable parts. Do not attempt to disassemble or repair the camera yourself.
- This camera's circuitry may switch off, even when a battery with sufficient power is installed. To resume operation, remove the battery and install it again.
- If *HELP* appears in the data panel, remove the battery, then re-install it. If it appears again after you release the shutter, take the camera to a MINOLTA Service Facility.

ACCESSORY INFORMATION

If you already have own Minolta accessories, check their compatibility before using them with your 2xi.

1. LENS

All Minolta AF lenses can be used with 2xi. Manual focusing lenses (MD or MC) cannot be attached the 2xi.

2. FLASH

Minolta i- and xi-series flash units can be used. Flash Shoe Adapter FS-1100 must be used to attach an AF-series flash to 2xi. When used with the 2xi, these units fire whenever a picture is taken, regardless of the exposure mode selected. In all exposure modes TTL flash control will operate.

3. OTHERS

Angle Finder and Magnifier cannot be used.

TECHNICAL DETAILS

AF system: Minolta's through-the-lens (TTL) phase-detection system with one wide CCD sensor; Predictive focus control; range: EV -1 - 18 (at ISO 100)

Metering: TTL-type; 8-segment honeycomb-pattern, silicon photo cell (SPC); second SPC for TTL flash metering of dedicated accessory flash

AE range:

8-segment metering: EV 1 - 20

Spot metering: EV 4 - 20 (both ISO 100, 50mm f/1.4)

TTL flash metering: Operates in all flash modes with dedicated units; X-sync shutter speed automatically set when flash is used; slow-shutter sync available in P, A, and S modes

Shutter: Electronically-controlled, vertical-traverse, focal-plane type

Automatic control: In program and aperture-priority modes, shutter speed set steplessly between 1/2000 and 30 sec.

Manual control: In shutter-priority and manual mode, shutter speeds selectable from 1/2000 to 30 sec. in 1-stop increments plus BULB in M mode

Film-speed setting: Automatic setting for DX-coded films; ISO 100 set for non-DX-coded films; range: ISO 25-5000 in 1/3-stop increments

Viewfinder: Eye-level fixed roof mirror showing 90% of field of view; magnification: 0.75X (with 50mm lens at infinity)

Power: 6-volt 2CR5 lithium battery

Battery performance: Approximately 60 rolls (based on Minolta's standard test method, using 24-exposure film)

Dimensions: 5-3/4 x 3-9/16 x 2-3/8 in. (146.5 x 91 x 60.5mm)

Weight: 13-9/16 oz. (385g) without lens and battery

Specifications and accessories are based on the latest information available at the time of printing and are subject to change at any time without notice.

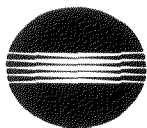

MINOLTA

Minolta Camera Co., Ltd.

Minolta GmbH

Minolta France S.A.

Minolta (UK) Limited

Minolta Austria Gesellschaft m.b.H.

Minolta Camera Benelux B.V.

Belgium Branch

Minolta (Schweiz) AG

Minolta Svenska AB

Finland Branch

Minolta Portugal Limitada

Minolta Corporation

Head Office

Los Angeles Branch

Minolta Canada Inc.

Head Office

Vancouver Branch

Minolta Hong Kong Limited

Minolta Singapore (Pte) Ltd.

3-13, 2-Chome, Azuchi-Machi, Chuo-Ku, Osaka 541, Japan

Kurt-Fischer-Strasse 50, D-22923 Ahrensburg, Germany

365-367 Route de Saint-Germain, 78420 Carrières-Sur-Seine, France

1-3 Tanners Drive, Blakelands North, Milton Keynes, MK14 5BU, England

Amalienstrasse 59-61, 1131 Wien, Austria

Zonnebaan 39, 3606 CH Maarssenbroek, P.B. 264, 3600 AG Maarssen, The Netherlands

Kontichsesteenweg 38, B-2630 Aartselaar, Belgium

Riedhof V, Riedstrasse 6 8953 Dielikon-Zürich, Switzerland

Brännkyrkagatan 64, Box 17074, S-10462 Stockholm 17, Sweden

Niittykatu 6 PL 37 SF-02201 Espoo, Finland

Av. do Brasil 33 a, 1700 Lisbon, Portugal

101 Williams Drive, Ramsey, New Jersey 07446, U.S.A.

11150 Hope Street Cypress, CA 90630, U.S.A.

369 Britannia Road East, Mississauga, Ontario L4Z 2H5, Canada

106-3850 Jacombs Road, Richmond, B.C. V6V 1Y6, Canada

Room 208, 2/F, Eastern Center, 1065 King's Road, Quarry Bay, Hong Kong

10, Teban Gardens Crescent, Singapore 2260

© 1992 Minolta Camera Co., Ltd. under the Berne
Convention and Universal Copyright Convention